

UNO-2174A/2178A

**Automation Computers with
Intel® Atom™ Processors,
6 x USB, 8 x COM, 2 x Mini-PCle**

User Manual

Copyright

This document is copyrighted, © 2010. All rights are reserved. The original manufacturer reserves the right to make improvements to the products described in this manual at any time without notice.

No part of this manual may be reproduced, copied, translated or transmitted in any form or by any means without the prior written permission of the original manufacturer. Information provided in this manual is intended to be accurate and reliable. However, the original manufacturer assumes no responsibility for its use, nor for any infringements upon the rights of third parties that may result from such use.

Acknowledgements

IBM, PC/AT, PS/2 and VGA are trademarks of International Business Machines Corporation.

Intel® and Pentium® are trademarks of Intel Corporation.

Microsoft Windows and MS-DOS are registered trademarks of Microsoft Corp.

C&T is a trademark of Chips and Technologies, Inc.

All other product names or trademarks are properties of their respective owners.

Support

For more information on this and other Advantech products, please visit our websites at: <http://www.advantech.com>

For technical support and service, please visit our support website at: <http://www.advantech.com/support/>

Part No. 2003217400

1st Edition

Printed in Taiwan

February 2011

Product Warranty

Advantech warrants to you, the original purchaser, that each of its products will be free from defects in materials and workmanship for one year from the date of purchase.

This warranty does not apply to any products that have been repaired or altered by persons other than repair personnel authorized by Advantech, or which have been subject to misuse, abuse, accident or improper installation. Advantech assumes no liability under the terms of this warranty as a consequence of such events.

Because of Advantech high quality-control standards and rigorous testing, most of our customers never need to use our repair service. If an Advantech product is defective, it will be repaired or replaced at no charge during the warranty period. For out-of-warranty repairs, you will be billed according to the cost of replacement materials, service time and freight. Please consult your dealer for more details. If you think you have a defective product, follow these steps:

- Step 1. Collect all the information about the problem encountered. (For example, CPU speed, Advantech products used, other hardware and software used, etc.) Note anything abnormal and list any on-screen messages you get when the problem occurs.
- Step 2. Call your dealer and describe the problem. Please have your manual, product, and any helpful information readily available.
- Step 3. If your product is diagnosed as defective, obtain an RMA (return merchandise authorization) number from your dealer. This allows us to process your return more quickly.
- Step 4. Carefully pack the defective product, a fully completed Repair and Replacement Order Card and a photocopy proof of purchase date (such as your sales receipt) in a shippable container. A product returned without proof of the purchase date is not eligible for warranty service.
- Step 5. Write the RMA number visibly on the outside of the package and ship it prepaid to your dealer.

Declaration of Conformity

CE

This product has passed the CE test for environmental specifications when shielded cables are used for external wiring. We recommend the use of shielded cables. This kind of cable is available from Advantech. Please contact your local supplier for ordering information.

FCC Class A

Note: This equipment has been tested and found to comply with the limits for a Class A digital device, pursuant to part 15 of the FCC Rules. These limits are designed to provide reasonable protection against harmful interference when the equipment is operated in a commercial environment. This equipment generates, uses, and can radiate radio frequency energy and, if not installed and used in accordance with the instruction manual, may cause harmful interference to radio communications. Operation of this equipment in a residential area is likely to cause harmful interference in which case the user will be required to correct the interference at his own expense.

Technical Support and Assistance

Step 1. Visit the Advantech web site at **www.advantech.com/support** where you can find the latest information about the product. Contact your distributor, sales representative, or Advantech's customer service center for technical support if you need additional assistance.

Safety Precaution - Static Electricity

Follow these simple precautions to protect yourself from harm and the products from damage. To avoid electrical shock, always disconnect the power from your PC chassis before you work on it. Don't touch any components on the CPU card or other cards while the PC is on. Disconnect power before making any configuration changes. The sudden rush of power as you connect a jumper or install a card may damage sensitive electronic components.

Caution

Danger of explosion if battery is incorrectly replaced. Replace only with the same or equivalent type battery as recommended by the manufacturer. Discard used batteries according to the manufacturer's instructions.

Safety Instructions

1. Read these safety instructions carefully.
2. Keep this User Manual for later reference.
3. Disconnect this equipment from any AC outlet before cleaning. Use a damp cloth. Do not use liquid or spray detergents for cleaning.
4. For plug-in equipment, the power outlet socket must be located near the equipment and must be easily accessible.
5. Keep this equipment away from humidity.
6. Put this equipment on a reliable surface during installation. Dropping it or letting it fall may cause damage.
7. The openings on the enclosure are for air convection. Protect the equipment from overheating. **DO NOT COVER THE OPENINGS.**
8. Make sure the voltage of the power source is correct before connecting the equipment to the power outlet.
9. Position the power cord so that people cannot step on it. Do not place anything over the power cord.
10. All cautions and warnings on the equipment should be noted.
11. If the equipment is not used for a long time, disconnect it from the power source to avoid damage by transient overvoltage.
12. Never pour any liquid into an opening. This may cause fire or electrical shock.
13. Never open the equipment. For safety reasons, the equipment should be opened only by qualified service personnel.
14. If one of the following situations arises, get the equipment checked by service personnel:
 15. The power cord or plug is damaged.
 16. Liquid has penetrated into the equipment.
 17. The equipment has been exposed to moisture.
 18. The equipment does not work well, or you cannot get it to work according to the user's manual.
 19. The equipment has been dropped and damaged.
 20. The equipment has obvious signs of breakage.
21. **DO NOT LEAVE THIS EQUIPMENT IN AN ENVIRONMENT WHERE THE STORAGE TEMPERATURE MAY GO BELOW -20° C (-4° F) OR ABOVE 70° C (158° F). THIS COULD DAMAGE THE EQUIPMENT. THE EQUIPMENT SHOULD BE IN A CONTROLLED ENVIRONMENT.**
22. **CAUTION: DANGER OF EXPLOSION IF BATTERY IS INCORRECTLY REPLACED. REPLACE ONLY WITH THE SAME OR EQUIVALENT TYPE RECOMMENDED BY THE MANUFAC-**

TURER, DISCARD USED BATTERIES ACCORDING TO THE MANUFACTURER'S INSTRUCTIONS.

23. The sound pressure level at the operator's position according to IEC 704-1:1982 is no more than 70 dB (A).

DISCLAIMER: This set of instructions is given according to IEC 704-1. Advantech disclaims all responsibility for the accuracy of any statements contained herein.

Contents

Chapter 1	Overview	2
1.1	Introduction	2
1.2	Hardware Specifications	3
1.3	Safety Precautions	5
1.4	Chassis Dimensions.....	6
	Figure 1.1:UNO-2174A Chassis Dimensions.....	6
	Figure 1.2:UNO-2178A Chassis Dimensions.....	6
1.5	Accessories.....	7
Chapter 2	Hardware Functionality	10
2.1	Introduction	10
	Figure 2.1:Front Panel of UNO-2174A	10
	Figure 2.2:Front Panel of UNO-2178A	10
	Figure 2.3:Rear Panel of UNO-2174A	10
	Figure 2.4:Rear Panel of UNO-2178A	10
2.2	UNO-2174A/2178A Interface (COM1~COM6).....	11
2.3	RS-232/422/485 Interface (COM A ~ B).....	11
2.3.1	16C550 UARTs with 128-byte standard	12
2.3.2	RS-422/485 detection	12
2.3.3	Automatic Data Flow Control Function for RS-485	12
2.4	Terminal Resistor Setup for RS-422/485	13
2.5	RS-232/422/485 Selection.....	14
2.5.1	COM1 - 6	14
	Figure 2.5:RS-232 Jumper Setting (COM1,2).....	14
	Figure 2.6:RS-232 Jumper Setting (COM3-6)	14
	Figure 2.7:RS-485 Jumper Setting (COM1,2).....	14
	Figure 2.8:RS-485 Jumper Setting (COM3-6)	15
2.5.2	COM A and COM B.....	15
2.5.3	RS-485 Auto Flow & RS-422 Master/Slave Mode	16
	Table 2.1:Auto Flow & Slave/Master Selection	16
2.6	LAN: Ethernet Connector	16
2.7	Power Connector	17
2.8	PS/2 Keyboard and Mouse Connector	17
2.9	USB Connector	17
2.10	VGA Display Connector	17
2.11	Battery Backup SRAM (Reserved).....	17
2.12	RTC Battery Specification	18
	Figure 2.9:RTC Battery Location	18
2.13	Power Button / Power Management.....	18
2.14	Reset Button	19
2.15	HD Audio	19

2.16	PCI Express Mini Card Socket.....	19
Chapter 3	Initial Setup.....	22
3.1	Inserting a CompactFlash Card.....	22
3.2	Chassis Grounding	22
	Figure 3.1:Chassis Grounding Connection.....	22
3.3	Connecting Power	23
3.4	Installing a Hard Disk	23
3.5	Installing a Wireless LAN Card and Antenna.....	24
3.6	BIOS Setup.....	25
Appendix A	System Settings and Pin Assignments	28
A.1	System I/O Address and Interrupt Assignment.....	28
A.2	Board Connectors and Jumpers.....	29
	Figure A.1:Connector & Jumper Locations (front).....	29
A.3	RS-232/485 Standard Serial Port (COM1~COM2)	31
A.4	RS-232/485 Serial Port (COM3-COM6)	32
A.5	RS-232/422/485 Serial Port (COM A ~ COM B).....	33
A.6	Power Connector (PWR).....	33
A.7	PS/2 Keyboard and Mouse Connector	34
A.8	USB Connector	34
A.9	VGA Display Connector	35
A.10	Clear CMOS (JP2)	36
	Table A.10:JP2 Clear CMOS.....	36
A.11	System Power AT or ATX Selection (JP1).....	36
	Table A.11:AT/ATX Selection.....	36

Overview

This chapter provides an overview of UNO-2174A/2178A's specifications.

Sections include:

- Introduction
- Hardware specification
- Safety precautions
- Chassis dimensions

Chapter 1 Overview

1.1 Introduction

UNO-2174A/2178A is an embedded Application Ready Platform (ARP) that can shorten your development time and offers rich networking interfaces to fulfill extensive needs in different projects. UNO-2174A and UNO-2178A include Intel's latest Atom technology and provide rich interfaces including up to 4 serial ports, 2 x GbE Lan, 6 x USB ports and Audio. UNO-2174A is equipped with an additional printer port and UNO-2178A can provide 4 additional serial ports through add-on cable.

UNO-2174A and UNO-2178A can operate in very wide temperatures (from -10 to 70° C). UNO-2178A even adopts D510 dual core Atom with great computing power for heavy programs. Energy Star certification ensure both UNO-2174A and UNO-2178A are very energy efficient.

UNO-2174A and UNO-2178A provide great expansion including 2 x Mini-PCIE and SIM card support. An additional daughterboard is also available for PC/104+ and PCI-104 plug in cards. With these expansions UNO-2174A and UNO-2178A have great expandability from WiFi, 3G, I/O expansion and fieldbus card.

With rich OS and driver support, such as Windows WES-2009, WES7, WinCE 6.0, and embedded Linux, users can integrate applications easily in an application ready platform that can provide a versatile functions to fulfill diverse requirements.

1.2 Hardware Specifications

General

- **Certifications** Energy Star, CE, FCC class A, UL, CCC, IP40, BSMI, C-Tick
- **Dimensions (W x D x H)** 2174A: 255 x 152 x 50 mm (10' x 6.0' x 2.0")
2178A: 255 x 152 x 59 mm (10' x 6.0' x 2.3")
- **Enclosure** Aluminum +SECC
- **Mounting** Wallmount, DIN-rail, VESA
- **Industrial Grounding** Isolation between chassis and power ground
- **Power Consumption** UNO-2174A: 12W (Typical)
UNO-2178A: 16W (Typical)
- **Power Requirements** 9 ~ 36 VDC (Min. 36 W)
- **Weight** 2.5 kg
- **OS Support** Windows XP/Win 7/WES7/ WES-2009/
CE 6.0, Linux
- **System Design** Fanless design with no internal cabling

System Hardware

- **CPU** 2174A: Intel Atom 1.6 GHz (N450)
2178A: Intel Atom 1.6 GHz DualCore (D510)
- **Memory** 2 GB DDR2 SDRAM built-in
- **Indicators** LEDs for Power, CF, LAN (Active, Status),
Serial (Tx, Rx)
- **Keyboard/Mouse** 1 x PS/2
- **Storage** CF: 1 x front-accessible type I/II CF slot
HDD: 1 x built-in 2.5" SATA HDD/SSD
bracket
- **Display** DB 15 VGA connector, UNO-2174A support
up to 1400 x 1050, UNO-2178A supports up
to 2048 x 1536
- **Watchdog Timer** Programmable 256 levels timer interval,
from 1 to 255 sec
- **Expansion Slot** 2 x full sized Mini-PCIE, 1x SIM card support
To use a wireless connection an expansion Mini-PCIE is required.

I/O Interface

- **Serial Ports** 2174A: 2 x RS-232/485 (COM1-2),
2 x RS-232/422/485 w/ 128kB FIFO (COM A-B)
2178A: 2 x RS-232/485 (COM1-2),
2 x RS-232/422/485 w/ 128kB FIFO (COMA-B),
4 x RS-232/485 from DB25 print port (COM3-6)
- **Serial Port Speed** 50-115.2 kbps (COM 1-6 in RS-232/485 mode)
50-115.2 kbps (COM A/B in RS-232 mode)
50-921.6 kbps (COM A/B RS-422/485 model)
- **LAN** 2 x 10/100/1000 Base-T RJ-45 ports
(Built-in boot ROM in flash BIOS) Teaming
function, Wake on LAN, Boot from LAN
- **Audio** 5.1 channel HD audio
- **USB Ports** 6 x USB 2.0
- **Printer Port (2174A)** 1 x DB25 print port

Environment

- **Humidity** 95% @ 40° C (non-condensing)
- **Operating Temperature** IEC 60068-2-2 with 100% CPU/ I/O loading
-10 ~ 70° C (14 ~ 158° F)
- **Ingress Protection** IP40
- **Shock Protection** IEC60068-2-27F: 50 G @ wallmount, 11 ms
HDD: 20 G @ wall mount, half sine, 11 ms
- **Vibration Protection** IEC60068-2-64 (Random1Oct./min,1hr/axis.)
CompactFlash: 2 Grms @ 5 ~ 500 Hz,
HDD: 1 Grms @ 5 ~ 500 Hz

Reserved Functions

- **Digital Input/Output:** 4 x DI and 4 x DO pin head*

*Note: This function is reserved for projects

Expansion Board (Additional Purchase Required)

- **PC/104+** 1 x PC/104+ (5V, 3A or 3.3V, 3A)
- **PCI-104** 1 x PCI-104 (5V, 3A or 3.3V, 3A)

Expansion Board Reserved Functions

- **Battery Backup SRAM*** 1MB
- **Mini-PCIe*** 1 x Mini-PCIe
- **HDD*** 1 x SATA II

*Note: This function is reserved for projects

1.3 Safety Precautions

The following sections tell how to make each connection. In most cases, you will simply need to connect a standard cable.

Warning!



Always disconnect the power cord from your chassis whenever you are working on it. Do not connect while the power is on. A sudden rush of power can damage sensitive electronic components. Only experienced electronics personnel should open the chassis.

Caution!

Always ground yourself to remove any static electric charge before touching UNO-2174A/2178A. Modern electronic devices are very sensitive to static electric charges. Use a grounding wrist strap at all times. Place all electronic components on a static-dissipative surface or in a static-shielded bag.

1.4 Chassis Dimensions

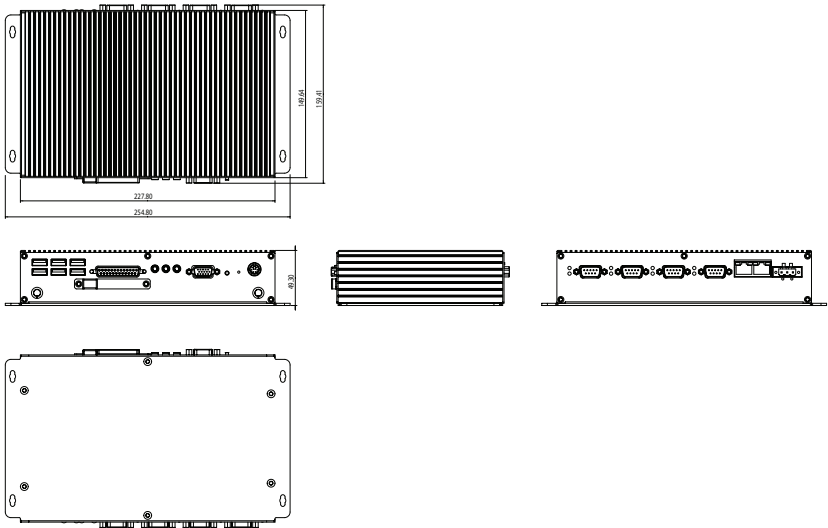

Figure 1.1: UNO-2174A Chassis Dimensions

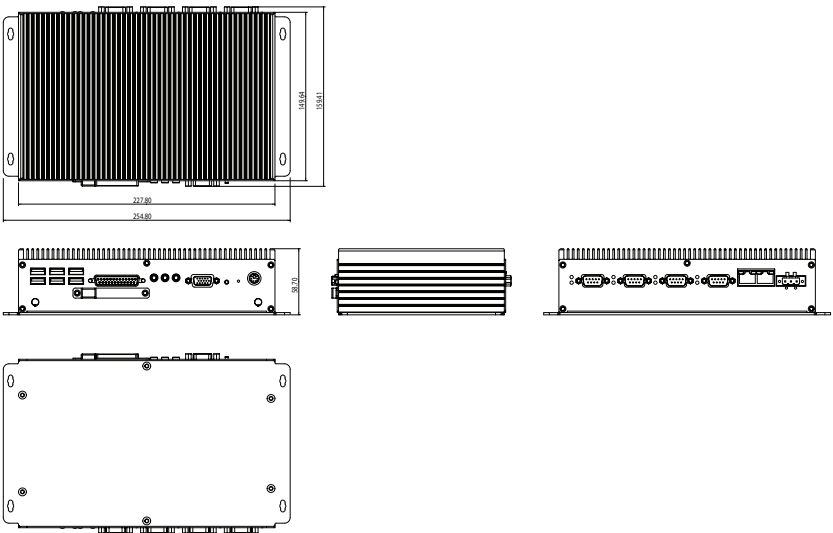

Figure 1.2: UNO-2178A Chassis Dimensions

1.5 Accessories

Please refer below for the accessory list:

- 3-pin connector for power wiring (Advantech P/N : 1652003206)
- SATA signal cable (Advantech P/N : 1700006812)
- SATA power cable (Advantech P/N : 1700004712)
- 8 PCS jumper (Advantech P/N : 1653302122)
- 4 COM port expansion cable (UNO-2178A only, P/N: 1700000146)
- Keyboard/Mouse Y cable (Advantech P/N : 1700060202)
- Driver DVD
- Warranty card

If anything is missing or damaged, contact your distributor or sales representative immediately.

Hardware Functionality

This chapter shows how to setup the UNO-2174A/2178A's hardware functions, including connecting peripherals, setting switches and indicators.

Sections include:

- Peripherals
- RS-232 Interface
- RS-422/485 Interface
- LAN / Ethernet Connector
- Power Connector
- PS/2 Mouse and Keyboard Connector
- USB Connector
- VGA Display Connector
- Reset Button

Chapter 2 Hardware Functionality

2.1 Introduction

The following figures show the connectors on UNO-2174A/2178A. The following sections give you information about each peripheral.

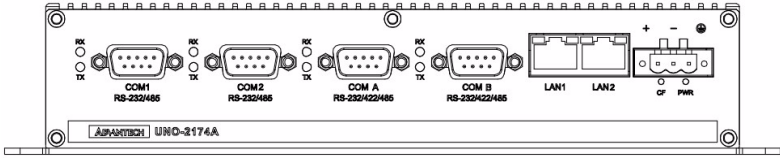

Figure 2.1: Front Panel of UNO-2174A

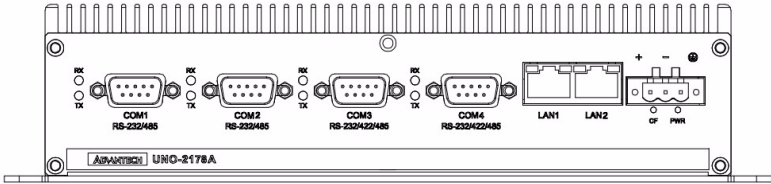

Figure 2.2: Front Panel of UNO-2178A

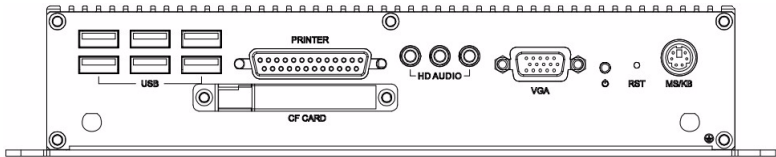

Figure 2.3: Rear Panel of UNO-2174A

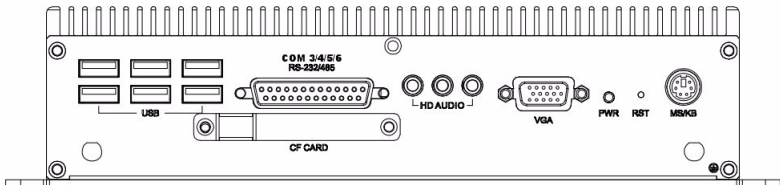

Figure 2.4: Rear Panel of UNO-2178A

2.2 UNO-2174A/2178A Interface (COM1~COM6)

UNO-2174A offers two standard RS-232/485 serial communication interface ports: COM1 and COM2.

Note: UNO-2178A offers additional 4 RS-232/485 COM port COM3 ~ COM6 through expansion cable connected from DB25 pin.

IRQ and Address Settings

The IRQ and I/O address range of COM1 to COM6 are listed below:

COM1: 3F8H, IRQ4

COM2: 2F8H, IRQ3

COM3: 3E8, IRQ10

COM4: 2E8, IRQ5

COM5: 2F0, IRQ11

COM6: 2E0, IRQ7

The setting can be adjust in bios page, the driver will be installed automatically during OS installation

2.3 RS-232/422/485 Interface (COM A ~ B)

The UNO-2174A/2178A offers two RS-232/422/485 serial communication interface ports: COMA and COMB. Please refer to Appendix A.4 for their pin assignments. The default setting of COMA and COMB are RS-422/485. Please note COM A/B in Microsoft Windows is showed as COM3,4 (UNO-2174A) or COM7,8 (UNO-2178A) in the device manager after driver is installed.

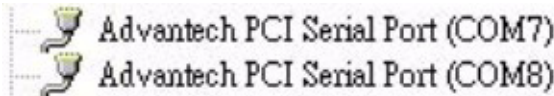

2.3.1 16C550 UARTs with 128-byte standard

Advantech UNO-2174A/2178A comes with OXuPCI952 UARTs containing 128 bytes FIFOs. These upgraded FIFOs greatly reduce CPU overhead and are an ideal choice for heavy multitasking environments.

2.3.2 RS-422/485 detection

In RS-422/485 mode, UNO-2174A/2178A automatically detects signals to match RS-422 or RS-485 networks. (No jumper change required)

2.3.3 Automatic Data Flow Control Function for RS-485

In RS-485 mode, UNO-2174A/2178A automatically detects the direction of incoming data and switches its transmission direction accordingly. So no handshaking signal (e.g. RTS signal) is necessary. This lets you conveniently build an RS-485 network with just two wires. More importantly, application software previously written for half duplex RS-232 environments can be maintained without modification.

2.4 Terminal Resistor Setup for RS-422/485

The onboard termination resistor (120 Ohm) for COM1-6, COM A, and COM B can be used for long distance transmission or device matching (Default Open).

Each terminal resistor responds to different channels for RS-422/485.

Usually, these resistors are needed for both ends of the communication wires and the value of the resistors should match the characteristic impedance of the wires used.

Terminal Resistor Settings				
COM Port	Switch	Pin	Setting	Description
COM 1,2	SW 11	1 (COM1)	ON	120 Ohm between Data+/ Data-
			OFF	Open (Default)
		2 (COM2)	ON	120 Ohm between Data+/ Data-
			OFF	Open (Default)
COM A COM B	SW 10 SW 9	1	ON	120 Ohm between Data+/ Data- (RS-485 COM A, B only) Or 120 Ohm between Tx+/ Tx- (RS-422)
			OFF	Open (Default)
		2	ON	120 Ohm between Rx+/ Rx- (RS-422)
			OFF	Open (Default)
COM 3 COM 4 COM 5 COM 6	SW 6	1 (COM3)	ON	120 Ohm between Data+/ Data-
		2 (COM4)		
		3 (COM5)	OFF	Open (Default)
		4 (COM6)		

2.5 RS-232/422/485 Selection

COM1 to COM2 support 9-wire RS-232 and RS-485 interfaces. COM3 to COM6 (UNO-2178A) support 4 wire RS-232 and RS-485 interfaces. COM A and COM B support 9-wire RS-232/422/485 interface. The system detects RS-422 or RS-485 automatically for COM A and COM B. To select between RS-232 or RS-485 for COM1 - COM6, adjust JCOM1 to JCOM6 accordingly. For COM A and COM B the corresponding jumpers are JCOM A and JCOM B.

2.5.1 COM1 - 6

Jumper Setting for RS-232 Interface (default)

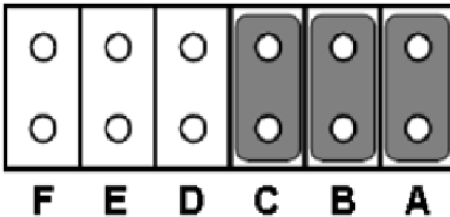

Figure 2.5: RS-232 Jumper Setting (COM1,2)

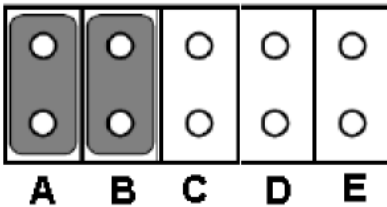

Figure 2.6: RS-232 Jumper Setting (COM3-6)

Jumper Setting for RS-485 Interface

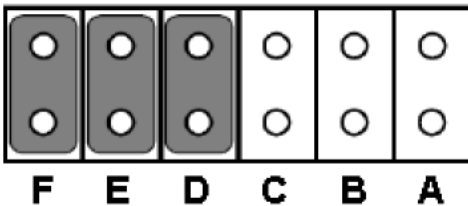

Figure 2.7: RS-485 Jumper Setting (COM1,2)

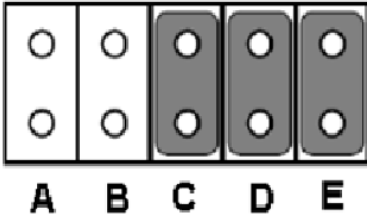
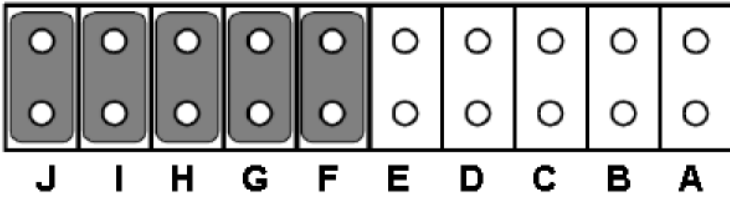

Figure 2.8: RS-485 Jumper Setting (COM3-6)

2.5.2 COM A and COM B

Jumper Setting for RS-422/485 Interface (default)



Jumper Setting for RS-232 Interface

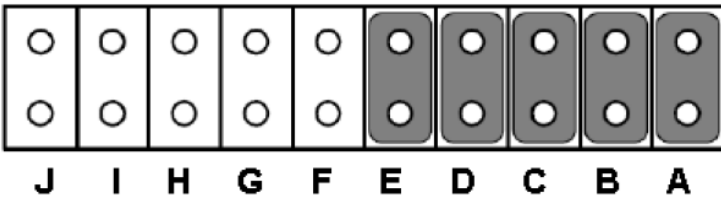

2.5.3 RS-485 Auto Flow & RS-422 Master/Slave Mode

You can set the “Auto Flow Control” mode of RS-485 or “Master/Slave” mode of RS-422 by using the SW4 DIP switch for COM A and COM B.

In RS-485, if the switch is set to “Auto”, the driver automatically senses the direction of the data flow and switches the direction of transmission. No handshaking is necessary.

In RS-422, if DIP switch is set to “On,” the driver is always enabled, and always in high or low status.

Table 2.1: Auto Flow & Slave/Master Selection

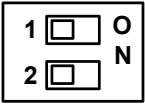
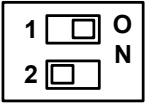
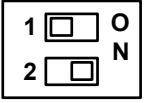
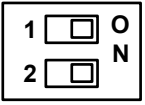
SW4 DIP Switch Setting	COM Port	Mode Selections
 <p>(Default)</p>	COM A	RS-422: Slave mode
		RS-485: Auto flow control
	COM B	RS-422: Slave mode
		RS-485: Auto flow control
	COM A	RS-422: Master mode
		RS-485: N/A
	COM B	RS-422: Slave mode
		RS-485: Auto flow control
	COM A	RS-422: Slave mode
		RS-485: Auto flow control
	COM B	RS-422: Master mode
		RS-485: N/A
	COM A	RS-422: Master mode
		RS-485: N/A
	COM B	RS-422: Master mode
		RS-485: N/A

2.6 LAN: Ethernet Connector

UNO-2174A/2178A is equipped with two Gigabit LAN controllers. The controller chip used in both model is RTL8111C Ethernet controller that is fully compliant with IEEE 802.3u 10/100Base-T CSMA/CD standards and IEEE 802.3ab specification for 1000Mbps Ethernet. The Ethernet port provides a standard RJ-45 jack on board, and LED indicators on the front side to show its Link (Green LED) and Active (Yellow LED) status.

2.7 Power Connector

The UNO-2174A/2178A comes with a Phoenix connector that carries 9~36 VDC external power input, and features reversed wiring protection. Therefore, it will not cause any damage to the system by reversed wiring of ground line and power line. Please refer to Appendix A.6

2.8 PS/2 Keyboard and Mouse Connector

The UNO-2174A/2178A provides a PS/2 keyboard and mouse connector. A 6-pin mini-DIN connector is located on the rear panel. The UNO-2174A/2178A comes with an adapter to convert from the 6-pin mini-DIN connector to two 6-pin mini-DIN connectors for PS/2 keyboard and PS/2 mouse connection.

2.9 USB Connector

The USB interface supports Plug and Play, which enables you to connect or disconnect a device whenever you want, without turning off the computer. UNO-2174A/UNO-2178A provides six connectors of USB interfaces, which gives complete Plug & Play and hot swapping for up to 127 external devices. The USB interface complies with USB EHCI, Rev. 2.0 compliant. The USB interface can be disabled in the system BIOS setup. Please refer to Appendix A.8 for its pin assignments.

2.10 VGA Display Connector

The UNO-2174A/2178A provides a VGA controller for a high resolution interface. UNO-2174A supports up to 1400 x 1050, UNO-2178A supports up to 2048 x 1536 maximum resolution.

2.11 Battery Backup SRAM (Reserved)

UNO-2174A/2178A reserves 1 MB of battery backed SRAM for projects on the expansion board. (Additional purchase required). This ensures that you have a safe place to store critical data. You can now write software applications without being concerned that system crashes will erase critical data from the memory. Please contact Advantech if this is function is required in your project.

2.12 RTC Battery Specification

UNO-2174A/2178A has RTC Battery to ensure the setting in bios and system clock can be kept, even with power disconnected for a short time.

- **Type:** BR2032 (Using CR2032 is NOT recommended)
- **Output Voltage:** 3 V_{DC}
- **Location:** BH1, please refer to below figure

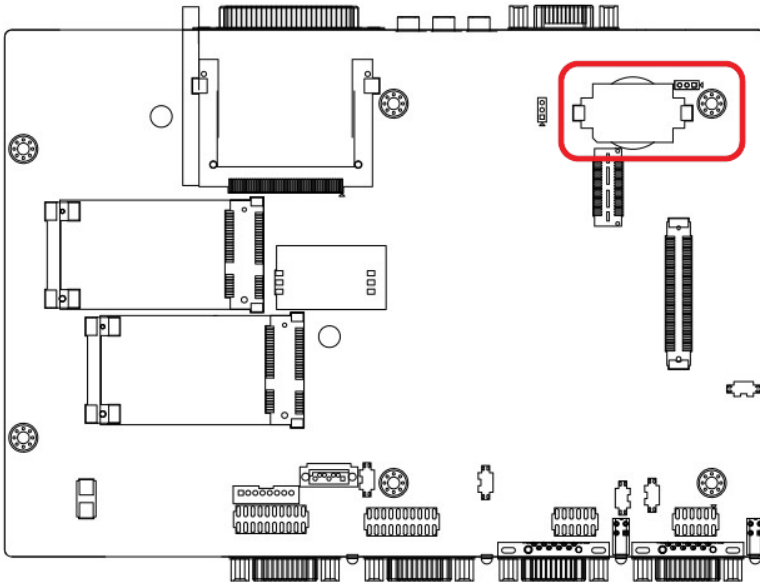

Figure 2.9: RTC Battery Location

2.13 Power Button / Power Management

Press the "PWR" button to power on or power off UNO-2174A/2178A (ATX type). UNO-2174A/2178A supports the ACPI (Advanced Configuration and Power Interface). Besides power on/off, it support multiple suspend modes, such as Power on Suspend (S1), Suspend to RAM (S3), Suspend to Disk (S4). In S3 and S4 suspend mode, the power consumption can be less than 2W which meet criteria of Energy Star.

2.14 Reset Button

Press the "Reset" button to activate the hardware reset function.

2.15 HD Audio

UNO-2174A/2178A is equipped with ALC892-GR which is a High Definition Audio Codec. UNO-2174A/2178AF provides 3 phone jack connector for 5.1 channel output. Please configure the function through provided software utility.

2.16 PCI Express Mini Card Socket

UNO-2174A/2178A supports two sockets for PCI Express mini cards. This interface is mainly target on the wireless application such as WLAN GPRS and 3G. User can install the card easily by the optional kit, please refer to Chapter 3.5 for the details.

An additional SIM card slot is used for 3G application. Please note you still require 3G Mini-PCIE module installed to be able to use 3G functions.

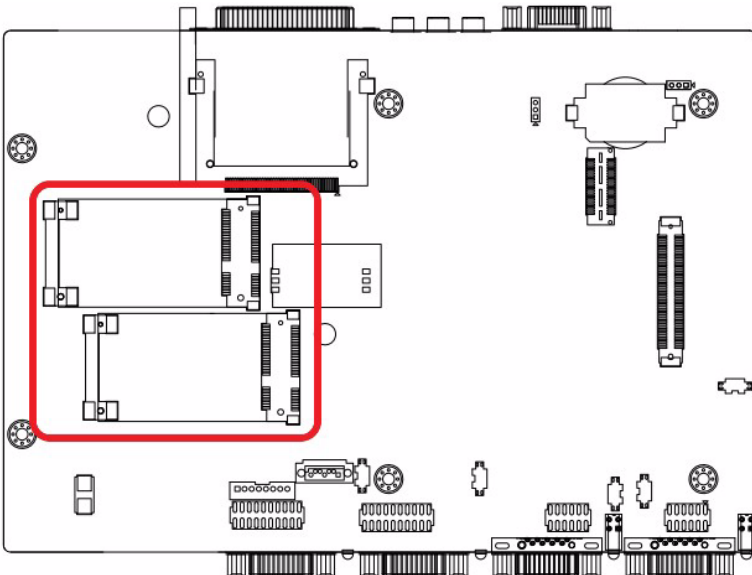

Initial Setup

This chapter introduces how to initialize the UNO-2174A/2178A.

Sections include:

- Inserting a CompactFlash Card
- Chassis Grounding
- Connecting Power
- Connecting a Hard Disk
- BIOS Setup and System Assignments

Chapter 3 Initial Setup

3.1 Inserting a CompactFlash Card

1. Remove the power cord.
2. Unscrew the two screws of CF cover in the front panel.
3. Plug a CompactFlash card with your OS and application program into a CompactFlash card slot on board.
4. Screw back the CF cover to ensure IP40 protection.

Note: The CompactFlash is allocated as "the Secondary IDE Master" by default.

User can change it to "Primary IDE Master" by BIOS setting. Please enter BIOS and select "Integrated Peripherals > IDE Device Setup > IDE Configuration > Enhanced Mode"

3.2 Chassis Grounding

UNO-2174A/2178A provides good EMI protection and a stable grounding base. There is an easy-to-connect chassis grounding point to use.

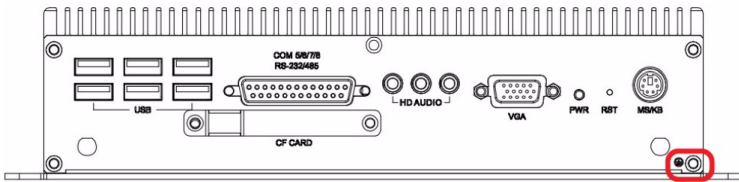

Figure 3.1: Chassis Grounding Connection

Please also note that system ground and chassis ground are separated in UNO-2174A/2178A

3.3 Connecting Power

Connect the UNO-2174A/2178A to a 9~36 VDC power source. The power source can either be from a power adapter or an in-house power source.

3.4 Installing a Hard Disk

The procedure for installing a hard disk into the UNO-2174A/2178A is below. Please follow these steps carefully. Please note the system is not compatible with +12V HDD. Please use an HDD with lower power input.

1. Remove the power cord.
2. Unscrew the six screws from the bottom panel.
3. Install the HDD on the HDD bracket.

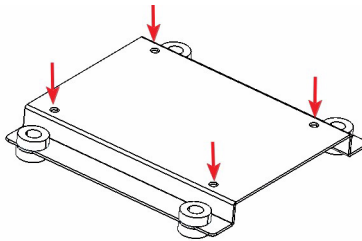

4. Connect the SATA signal cable to CN33 and connect SATA power cable to CN34, then connect the other side of the cable to the SATA hard disk.

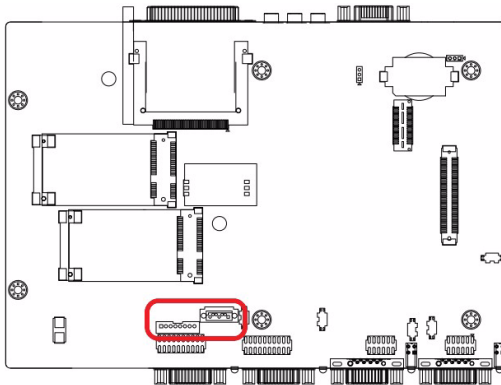

5. Screw back the bottom panel with the six screws.

3.5 Installing a Wireless LAN Card and Antenna

Please contact Advantech to prepare the following optional kit:

Rear Panel for Antenna

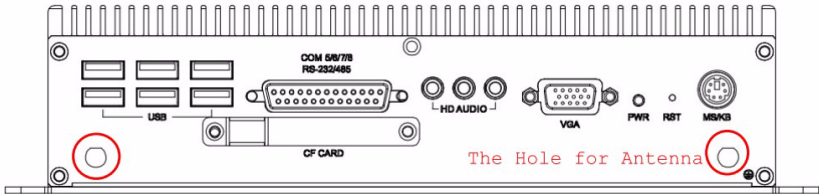

- The internal cable : 1700001854 (11cm)

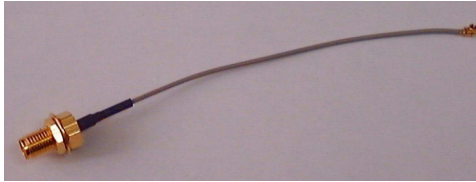

Wireless Module (PCI Express mini card)

- One of the suggested module is 968EMW0021 which is a verified Wireless IEEE 802.11b/g/n module

Antenna

- Please select the necessary specification according to your application.
- One of the suggested antenna is a verified 802.11b/g/n 5dBi Dipole Antenna



Then follow the below steps for the installation:

1. Unscrew the bottom panel and open it.
2. Remove the hole(s) on the rear panel for antenna installation.
3. Install the internal cable 1700001854 on the rear panel.

4. Plug the Wireless module onto the PCI Express mini card socket (CN27 or CN31)

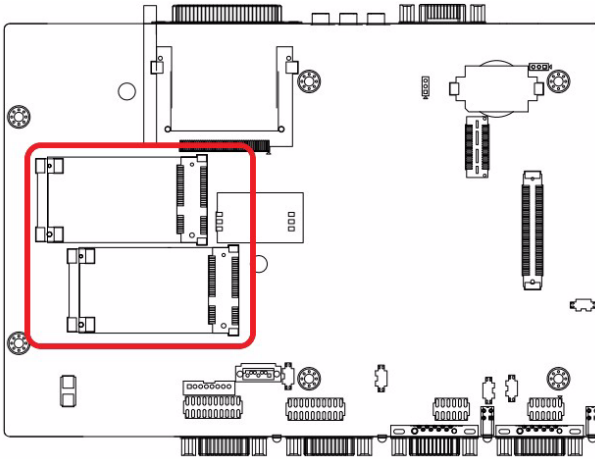

5. Connect the internal cable with the module.
6. Screw back the bottom panel.
7. Assemble the antenna on the SMA connector.

3.6 BIOS Setup

Press "DEL" in the boot-up screen to enter the BIOS setup utility. Please follow the instruction on the screen to do the necessary settings.

Please note that you can try to "Load Optimized Defaults" from the BIOS Setup manual if the UNO-2174A/2178A does not work properly.

Appendix

A

System Settings and Pin Assignments

Appendix A System Settings and Pin Assignments

A.1 System I/O Address and Interrupt Assignment

Interrupt No.	Interrupt Source
NMI	Parity Error Detected
IRQ 0	Interval timer
IRQ 1	Keyboard
IRQ 2	Interrupt from controller 2 (cascade)
IRQ 3	COM 2
IRQ 4	COM 1
IRQ 5	COM 4
IRQ 6	Diskette controller (FDC)
IRQ 7	COM 6
IRQ 8	Real-time clock
IRQ 9	Microsoft ACPI-Compliant System
IRQ 10	COM 3
IRQ 11	COM 5
IRQ 12	Microsoft PS/s Mouse
IRQ 13	INT from co-processor
IRQ 14	Primary IDE
IRQ 15	Secondary IDE

A.2 Board Connectors and Jumpers

There are several connectors and jumpers on the UNO-2174A/2178A board. The following sections tell you how to configure the UNO-2174A/2178A hardware setting. Figure A-1 shows the locations of UNO-2174A/2178A's connectors and jumpers.

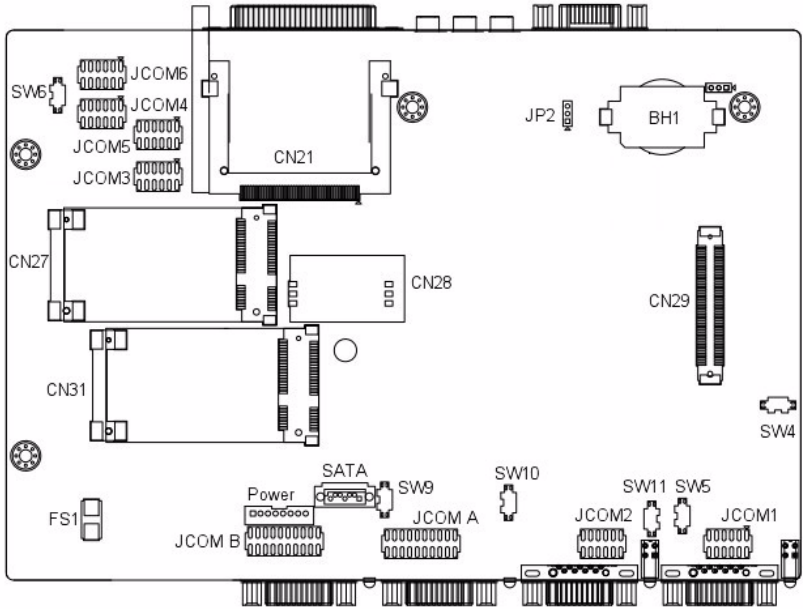

Figure A.1: Connector & Jumper Locations (front)

Table A.2: UNO-2174A/2178A Connectors and Jumpers

Label	Function
FS1	Fuse for input DC power
CN26 CN32	PCI Express mini Card Socket
CN33	SATA signal connector
CN34	SATA power connector
SW11	Switch for terminal resistor of COM1, 2
SW10	Switch for terminal resistor of COM A
SW9	Switch for terminal resistor of COM B
SW6	Switch for terminal resistor of COM 3-6
SW4	Switch for COMA/COMB RS-422 master/slave selection
JP2	Clear CMOS
BH1	Battery for RTC
JCOM1-6	RS-232/485 selection for COM1-6
JCOM A	RS-232/422/485 selection for COM A
JCOM B	RS-232/422/485 selection for COM B
SATA	Sata HD Data connector
Power	Sata HD Power connector
CN29	Connector for PC/104+ & PCI-104 expansion board
JP1	System power AT or ATX selection

A.3 RS-232/485 Standard Serial Port (COM1~COM2)

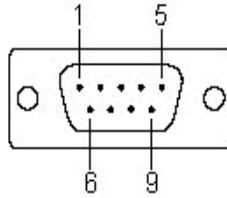

Table A.3: RS-232 Standard Serial Port Pin Assignments

Pin	RS-232 Signal Name	RS-485 Signal Name
1	DCD	DATA-
2	RxD	DATA+
3	TxD	NC
4	DTR	NC
5	GND	GND
6	DSR	NC
7	RTS	NC
8	CTS	NC
9	RI	NC

A.4 RS-232/485 Serial Port (COM3-COM6)

This function is enabled through expansion cable (UNO-2178A only).

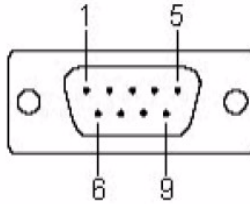

Table A.4: RS-232/485 Serial Port Pin Assignments

Pin	RS-232 Signal Name	RS-485 Signal Name
1	NC	Data-
2	RxD	Data+
3	TxD	NC
4	NC	NC
5	GND	GND
6	NC	NC
7	RTS	NC
8	CTS	NC
9	NC	NC

A.5 RS-232/422/485 Serial Port (COM A ~ COM B)

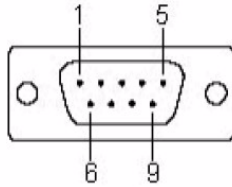

Table A.5: RS-232/422/485 Serial Port Pin Assignments

Pin	RS-232	RS-422	RS-485
1	DCD	TX-	Data-
2	RxD	TX+	Data+
3	TxD	RX+	NC
4	DTR	RX-	NC
5	GND	GND	GND
6	DSR	NC	NC
7	RTS	NC	NC
8	CTS	NC	NC
9	RI	NC	NC

A.6 Power Connector (PWR)

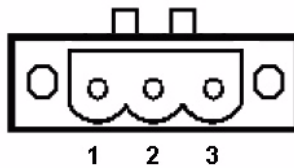

Table A.6: Power connector pin assignments

Pin	
1	V+ (9~36V _{DC})
2	V-
3	Field Ground

A.7 PS/2 Keyboard and Mouse Connector

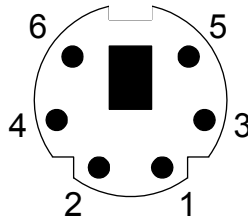

Table A.7: Keyboard and Mouse connector pin assignments

Pin	Signal Name
1	KB DATA
2	MS DATA
3	GND
4	VCC
5	KB Clock
6	MS Clock

A.8 USB Connector

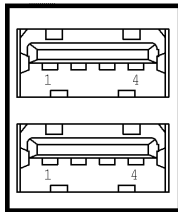

Table A.8: USB connector pin assignments

Pin	Signal Name	Cable Color
1	VCC	Red
2	DATA+	White
3	DATA-	Green
4	GND	Black

A.9 VGA Display Connector

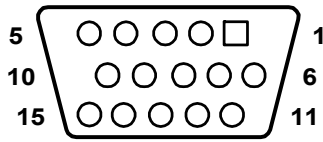

Table A.9: VGA adaptor cable pin assignment

Pin	Signal Name
1	Red
2	Green
3	Blue
4	NC
5	GND
6	GND
7	GND
8	GND
9	NC
10	GND
11	NC
12	NC
13	H-SYNC
14	V-SYNC
15	NC

A.10 Clear CMOS (JP2)

This jumper is used to erase CMOS data and reset system BIOS information. Follow the procedures below to clear the CMOS.

1. Turn off the system.
2. Close jumper JP2 (2-3) to clear CMOS .
- 3, Remove jumper JP2 (1-2)
3. Turn on the system. The CMOS is now cleared.
4. Turn on the system. The BIOS is reset to its default setting.

Table A.10: JP2 Clear CMOS

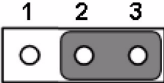
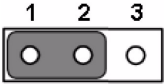
Configuration	Function
	Clear CMOS
	Normal (Default)

A.11 System Power AT or ATX Selection (JP1)

UNO-2174A/2178A can set AT or ATX power mode in the bios or hardware jumper setting.

Table A.11: AT/ATX Selection

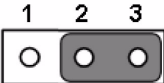
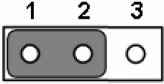
Configuration	Function
	AT mode
	ATX mode (default)
