

User Manual

# UNO-2483G UNO-2473G

Intel® Core™ i7/i3/Celeron/Atom  
Regular-Size Automation  
Computer w/ 4 x GbE 2 x mPCIe,  
HDMI/VGA

**ADVANTECH**

*Enabling an Intelligent Planet*

---

## Copyright

The documentation and the software included with this product are copyrighted 2014 by Advantech Co., Ltd. All rights are reserved. Advantech Co., Ltd. reserves the right to make improvements in the products described in this manual at any time without notice. No part of this manual may be reproduced, copied, translated or transmitted in any form or by any means without the prior written permission of Advantech Co., Ltd. Information provided in this manual is intended to be accurate and reliable. However, Advantech Co., Ltd. assumes no responsibility for its use, nor for any infringements of the rights of third parties, which may result from its use.

## Acknowledgements

IBM, PC/AT, PS/2 and VGA are trademarks of International Business Machines Corporation.

Intel®, Core™ and Atom™ are the trademarks of Intel Corporation

Microsoft Windows and MS-DOS are registered trademarks of Microsoft Corp.

All other product names or trademarks are properties of their respective owners.

## Support

For more information on this and other Advantech products, please visit our websites at: <http://www.advantech.com>

For technical support and service, please visit our support website at: <http://support.advantech.com/>

## Product Warranty (2 years)

Advantech warrants to you, the original purchaser, that each of its products will be free from defects in materials and workmanship for two years from the date of purchase.

This warranty does not apply to any products which have been repaired or altered by persons other than repair personnel authorized by Advantech, or which have been subject to misuse, abuse, accident or improper installation. Advantech assumes no liability under the terms of this warranty as a consequence of such events.

Because of Advantech's high quality-control standards and rigorous testing, most of our customers never need to use our repair service. If an Advantech product is defective, it will be repaired or replaced at no charge during the warranty period. For out-of-warranty repairs, you will be billed according to the cost of replacement materials, service time and freight. Please consult your dealer for more details.

If you think you have a defective product, follow these steps:

1. Collect all the information about the problem encountered. (For example, CPU speed, Advantech products used, other hardware and software used, etc.) Note anything abnormal and list any onscreen messages you get when the problem occurs.
2. Call your dealer and describe the problem. Please have your manual, product, and any helpful information readily available.
3. If your product is diagnosed as defective, obtain an RMA (return merchandise authorization) number from your dealer. This allows us to process your return more quickly.
4. Carefully pack the defective product, a fully-completed Repair and Replacement Order Card and a photocopy proof of purchase date (such as your sales receipt) in a shippable container. A product returned without proof of the purchase date is not eligible for warranty service.
5. Write the RMA number visibly on the outside of the package and ship it prepaid to your dealer.

## Declaration of Conformity

### CE

This product has passed the CE test for environmental specifications when shielded cables are used for external wiring. We recommend the use of shielded cables. This kind of cable is available from Advantech. Please contact your local supplier for ordering information.

### FCC Class A

Note: This equipment has been tested and found to comply with the limits for a Class A digital device, pursuant to part 15 of the FCC Rules. These limits are designed to provide reasonable protection against harmful interference when the equipment is operated in a commercial environment. This equipment generates, uses, and can radiate radio frequency energy and, if not installed and used in accordance with the instruction manual, may cause harmful interference to radio communications. Operation of this equipment in a residential area is likely to cause harmful interference in which case the user will be required to correct the interference at his own expense.

---

## Technical Support and Assistance

1. Visit the Advantech web site at [www.advantech.com/support](http://www.advantech.com/support) where you can find the latest information about the product.
2. Contact your distributor, sales representative, or Advantech's customer service center for technical support if you need additional assistance. Please have the following information ready before you call:
  - Product name and serial number
  - Description of your peripheral attachments
  - Description of your software (operating system, version, application software, etc.)
  - A complete description of the problem
  - The exact wording of any error messages

## Safety Precaution - Static Electricity

Follow these simple precautions to protect yourself from harm and the products from damage.

- To avoid electrical shock, always disconnect the power from your PC chassis before you work on it. Don't touch any components on the CPU card or other cards while the PC is on.
- Disconnect power before making any configuration changes. The sudden rush of power as you connect a jumper or install a card may damage sensitive electronic components.

# Safety Instructions

1. Read these safety instructions carefully.
2. Keep this User Manual for later reference.
3. Disconnect this equipment from any AC outlet before cleaning. Use a damp cloth. Do not use liquid or spray detergents for cleaning.
4. For plug-in equipment, the power outlet socket must be located near the equipment and must be easily accessible.
5. Keep this equipment away from humidity.
6. Put this equipment on a reliable surface during installation. Dropping it or letting it fall may cause damage.
7. The openings on the enclosure are for air convection. Protect the equipment from overheating. **DO NOT COVER THE OPENINGS.**
8. Make sure the voltage of the power source is correct before connecting the equipment to the power outlet.
9. Position the power cord so that people cannot step on it. Do not place anything over the power cord.
10. All cautions and warnings on the equipment should be noted.
11. If the equipment is not used for a long time, disconnect it from the power source to avoid damage by transient overvoltage.
12. Never pour any liquid into an opening. This may cause fire or electrical shock.
13. Never open the equipment. For safety reasons, the equipment should be opened only by qualified service personnel.
14. If one of the following situations arises, get the equipment checked by service personnel:
  15. The power cord or plug is damaged.
  16. Liquid has penetrated into the equipment.
  17. The equipment has been exposed to moisture.
  18. The equipment does not work well, or you cannot get it to work according to the user's manual.
  19. The equipment has been dropped and damaged.
  20. The equipment has obvious signs of breakage.
21. **DO NOT LEAVE THIS EQUIPMENT IN AN ENVIRONMENT WHERE THE STORAGE TEMPERATURE MAY GO BELOW -20° C (-4° F) OR ABOVE 60° C (140° F). THIS COULD DAMAGE THE EQUIPMENT. THE EQUIPMENT SHOULD BE IN A CONTROLLED ENVIRONMENT.**
22. **CAUTION: DANGER OF EXPLOSION IF BATTERY IS INCORRECTLY REPLACED. REPLACE ONLY WITH THE SAME OR EQUIVALENT TYPE RECOMMENDED BY THE MANUFACTURER, DISCARD USED BATTERIES ACCORDING TO THE MANUFACTURER'S INSTRUCTIONS.**
23. **ATTENTION: Danger d'explosion si la batterie est mal REMPLACÉ. REMPLACER UNIQUEMENT PAR LE MEME TYPE OU EQUIVALENT RECOMMANDÉ PAR LE FABRICANT, jeter les piles usagées SELON LES INSTRUCTIONS DU FABRICANT.**
24. The sound pressure level at the operator's position according to IEC 704-1:1982 is no more than 70 dB (A).

**DISCLAIMER:** This set of instructions is given according to IEC 704-1. Advantech disclaims all responsibility for the accuracy of any statements contained herein.



# Contents

<b>Chapter 1</b>	<b>Overview.....</b>	<b>1</b>
1.1	Introduction .....	2
1.2	Safety Precautions .....	2
1.3	Accessories.....	3
<b>Chapter 2</b>	<b>Hardware Functionality .....</b>	<b>5</b>
2.1	Introduction .....	6
	Figure 2.1 Front Panel of UNO-2483G/UNO-2473G .....	6
	Figure 2.2 Rear Panel of UNO-2483G/UNO-2473G.....	6
2.2	UNO-2483G/UNO-2473G Interface (COM1~COM4).....	6
2.2.1	RS-232 Interface (COM 1 ~ 2).....	6
2.2.2	RS-422/485 detection .....	6
2.2.3	Automatic Data Flow Control Function for RS-485 .....	7
2.3	LAN: Ethernet Connector .....	7
2.4	Power Connector .....	7
2.5	USB Connector .....	7
2.6	HDMI Display Connector.....	7
2.7	RTC Battery Specification .....	8
	Figure 2.3 RTC Battery Location .....	8
2.8	Power Button/Power Management .....	8
2.9	Reset Button .....	8
2.10	HD Audio.....	8
2.11	PCI Express Mini Card Socket.....	9
<b>Chapter 3</b>	<b>Initial Setup .....</b>	<b>11</b>
3.1	Inserting a mSATA .....	12
3.2	Chassis Grounding.....	12
	Figure 3.1 Chassis Grounding Connection.....	12
3.3	Connecting Power .....	12
3.4	Installing a Hard Disk .....	13
3.5	Installing a Wireless LAN Card and Antenna .....	14
3.6	BIOS Setup .....	15
3.7	AMT Configuration .....	16
3.8	Teaming Configuration.....	18
3.9	Enabling RAID in BIOS .....	20
<b>Appendix A</b>	<b>System Settings and Pin Assignments</b>	<b>21</b>
A.1	System I/O Address and Interrupt Assignment .....	22
	Table A.1: Interrupt Assignments.....	22
A.2	Board Connectors and Jumpers .....	23
	Figure A.1 Connector & Jumper Locations (front).....	23
	Table A.2: Connectors and Jumpers .....	23
A.3	RS-232 Standard Serial Port.....	24
	Table A.3: RS-232 Serial Port Pin Assignments.....	24
A.4	RS-422/485 Serial Port .....	24
	Table A.4: RS-422/485 Serial Port Pin Assignments.....	24
A.5	Power Connector (PWR).....	25
	Table A.5: Power connector pin assignments.....	25

---

A.6	USB Connector .....	26
	Table A.6: USB 2.0 Connector Pin Assignments.....	26
	Table A.7: USB 3.0 Connector Pin Assignments.....	26
A.7	HDMI Display Connector .....	27
	Table A.8: HDMI Display Connector.....	27
A.8	Clear CMOS (JP1).....	27
	Table A.9: JP2 Clear CMOS.....	27



# Chapter 1

## Overview

This chapter provides an overview of UNO-2483G/UNO-2473G specifications.

Sections include:

- Introduction
- Hardware specification
- Safety precautions
- Chassis dimensions

## 1.1 Introduction

The UNO-2483G/2473G is an embedded Application Ready Platform (ARP) that can shorten your development time and offers a wide array of networking interfaces to fulfill the extensive needs of different projects. UNO-2483G/2473G includes Intel's latest Core i7/i3/Celeron/Atom technology and provide rich interfaces including up to 4 serial ports, 4 x GbE LAN, 4 x USB ports and Audio. UNO-2483G/2473G supports two display types, VGA and HDMI for various high resolution requirements and also Advantech latest iDoor technology.

The UNO-2483G/2473G can operate in wide temperatures (from -20 to 60°C). The UNO-2483G/2473G also uses Intel Core i7/i3/Celeron/Atom CPUs with great computing power and built-in up to 8G DDR3 RAM for heavy programs.

The UNO-2483G/2473G provides great expansion including 2 x Mini-PCIe and SIM card support. With these expansions UNO-2483G/2473G has great expandability from Wi-Fi, 3G, I/O expansion and industrial protocols with iDoor technology.

With multiple OS and driver support, such as Windows 7/8, WES7, and embedded Linux, users can integrate applications easily in an application ready platform that can provide versatile functions to fulfill diverse requirements.

## 1.2 Safety Precautions

The following sections tell how to make each connection. In most cases, you will simply need to connect a standard cable.

**Warning!** *Always disconnect the power cord from your chassis whenever you are working on it. Do not connect while the power is on. A sudden rush of power can damage sensitive electronic components. Only experienced electronics personnel should open the chassis.*



**Warning!** *Toujours à la terre pour éliminer toute charge d'électricité statique avant toucher UNO-2362G. Appareils électroniques modernes sont très sensibles à charges d'électricité statique. Utilisez un bracelet antistatique à tout moment. Placez tous composants électroniques sur une surface antistatique ou dans un statique-sac blindé.*



**Caution!** *Always ground yourself to remove any static electric charge before touching UNO-2483G/UNO-2473G. Modern electronic devices are very sensitive to static electric charges. Use a grounding wrist strap at all times. Place all electronic components on a static-dissipative surface or in a static-shielded bag.*



**Caution!** *Toujours débrancher le cordon d'alimentation de votre boîtier lorsque vous êtes travailler. Ne branchez pas lorsque l'appareil est allumé. Un afflux soudain de puissance peut endommager les composants électroniques sensibles. Seulement connu personnel de l'électronique devraient ouvrir le châssis.*



## 1.3 Accessories

Please refer below for the accessory list:

- 3-pin connector for power wiring (Advantech P/N: 1652003206)
- HDD screws (Advantech P/N: 1930000687)
- mPCIe screws (Advantech P/N: 1935020300)
- 2 PCS jumper (Advantech P/N: 1653302122)
- Mounting Screws (Advantech P/N:xxxxxxx)
- Driver DVD
- Warranty card

If anything is missing or damaged, contact your distributor or sales representative immediately.



# Chapter 2

## Hardware Functionality

This chapter shows how to setup the UNO-2483G/UNO-2473G's hardware functions, including connecting peripherals, setting switches and indicators.

Sections include:

- Peripherals
- RS-232 Interface
- RS-422/485 Interface
- LAN / Ethernet Connector
- Power Connector
- Power eSATA
- PS/2 Mouse and Keyboard Connector
- Audio Connector
- USB Connector
- HDMI Display Connector
- Reset Button

## 2.1 Introduction

The following figures show the connectors on UNO-2483G/UNO-2473G. The following sections give you information about each peripheral.

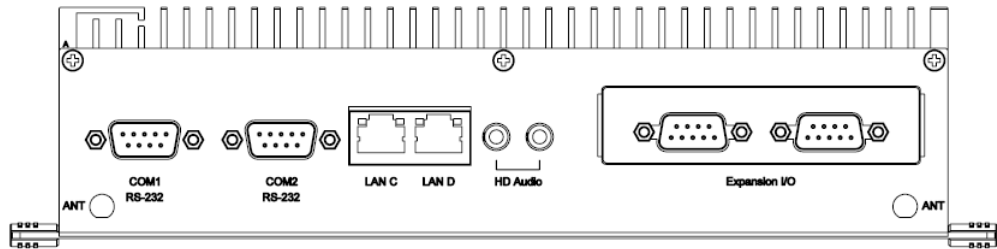

Figure 2.1 Front Panel of UNO-2483G/UNO-2473G

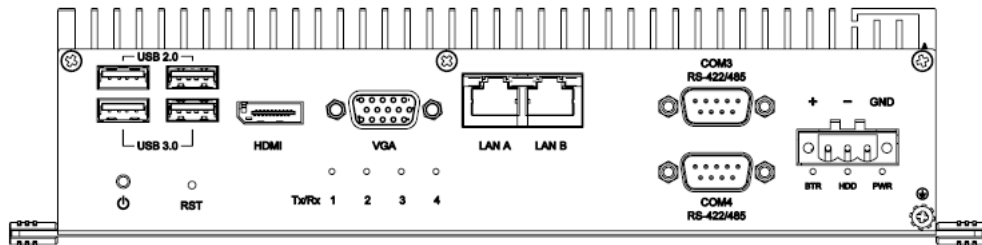

Figure 2.2 Rear Panel of UNO-2483G/UNO-2473G

## 2.2 UNO-2483G/UNO-2473G Interface (COM1~COM4)

UNO-2483G/UNO-2473G offers two standard RS-232 and two RS-232/485 (with cable) serial communication interface ports: COM1 ~ COM4.

The IRQ and I/O address range of COM1 to COM4 are listed below:

COM1: 3F8h, IRQ4

COM2: 2F8h, IRQ3

COM3: 3E8h, IRQ10

COM4: 2E8h, IRQ5

The setting can be adjusted in the bios page, the driver will be installed automatically during OS installation

### 2.2.1 RS-232 Interface (COM 1 ~ 2)

The UNO-2483G/UNO-2473G offers two RS-232 serial communication interface ports: COM1 and COM2. Please refer to Appendix A.4 for their pin assignments.

### 2.2.2 RS-422/485 detection

In RS-422/485 mode, UNO-2483G/UNO-2473G automatically detects signals to match RS-422 or RS-485 networks. (No jumper change required)

### 2.2.3 Automatic Data Flow Control Function for RS-485

In RS-485 mode, UNO-2483G/UNO-2473G automatically detects the direction of incoming data and switches its transmission direction accordingly. So no handshaking signal (e.g. RTS signal) is necessary. This lets you conveniently build an RS-485 network with just two wires. More importantly, application software previously written for half duplex RS-232 environments can be maintained without modification.

## 2.3 LAN: Ethernet Connector

UNO-2483G/UNO-2473G is equipped with four Gigabit LAN controllers. The controller chip used in both model are Intel 1 x i218 and 3 x i210 Ethernet controller that is fully compliant with IEEE 802.3u 10/100Base-T CSMA/CD standards and IEEE 802.3ab specification for 1000Mbps Ethernet. The Ethernet port provides a standard RJ-45 jack on board, and LED indicators on the front side to show its Link (Green LED) and Active (Yellow LED) status.

**Note!** UNO-2483G/UNO-2473G with i218 LAN chip can support AMT7.0.



## 2.4 Power Connector

The UNO-2483G/UNO-2473G comes with a Phoenix connector that carries 24 V<sub>DC</sub> external power input, and features reversed wiring protection. Therefore, it will not cause any damage to the system by reversed wiring of ground line and power line. Please refer to Appendix A.6

## 2.5 USB Connector

The USB interface supports Plug and Play, which enables you to connect or disconnect a device whenever you want, without turning off the computer. The UNO-2483G/2473G provides four connectors of USB interfaces, which gives complete Plug & Play and hot swapping for up to 127 external devices. Two of the four connectors are USB 3.0 standard. The USB interface complies with USB EHCI, Rev. 2.0 compliant. The USB interface can be disabled in the system BIOS setup. Please refer to Appendix A.6 for its pin assignments.

## 2.6 HDMI Display Connector

The UNO-2483G/2473G provides a HDMI controller for a high resolution interface. The UNO-2483G/2473G supports up to full HD resolution for two independent display.

## 2.7 RTC Battery Specification

The UNO-2483G/2473G has an RTC Battery to ensure the setting in bios and system clock can be kept, even with power disconnected for a short time.

- **Type:** BR2032 (Using CR2032 is NOT recommended)
- **Output Voltage:** 3 V<sub>DC</sub>
- **Location:** BH1, please refer to below figure

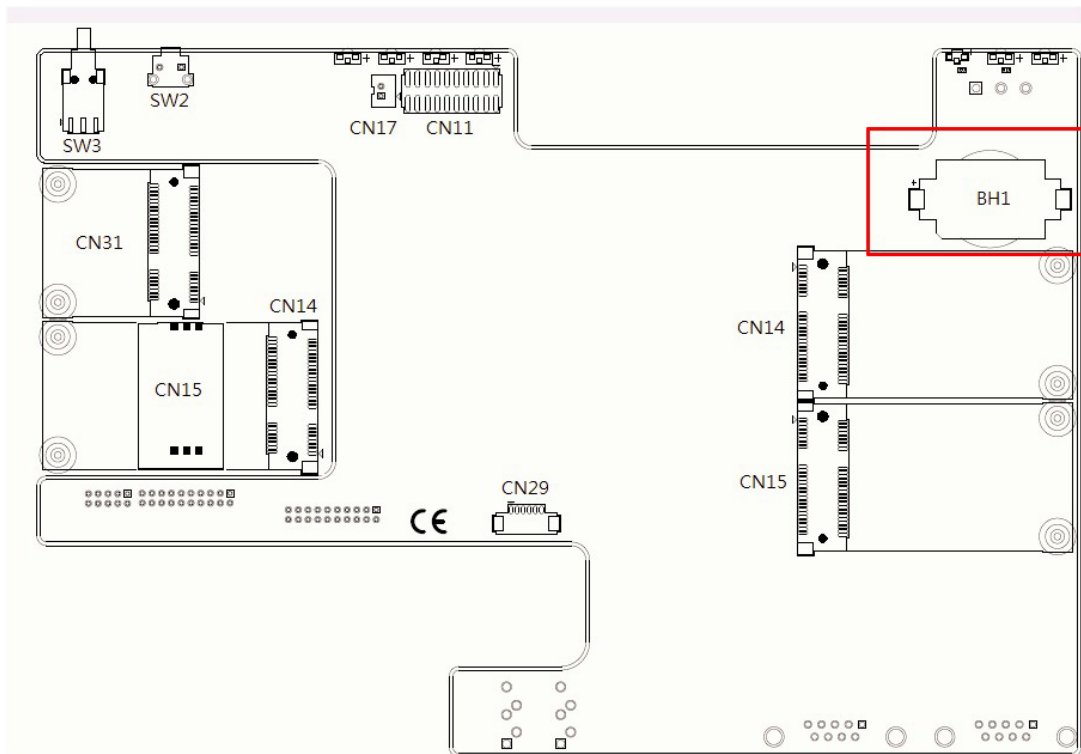

Figure 2.3 RTC Battery Location

## 2.8 Power Button/Power Management

Press the "PWR" button to power on or power off the UNO-2483G/2473G (ATX type). The UNO-2483G/2473G supports the ACPI (Advanced Configuration and Power Interface). Besides power on/off, it supports multiple suspend modes, such as Power on Suspend (S1), Suspend to RAM (S3), Suspend to Disk (S4). In S3 and S4 suspend mode, the power consumption can be less than 2W which meets criteria of Energy Star.

## 2.9 Reset Button

Press the "Reset" button to activate the hardware reset function.

## 2.10 HD Audio

The UNO-2483G/2473G is equipped with ALC888S which is a High Definition Audio Codec. The UNO-2483G/2473G provides 2 phone jack connectors for 5.1 channel output. Please configure the function through provided software utility.



## 2.11 PCI Express Mini Card Socket

The UNO-2483G/2473G supports two sockets for full size PCI Express mini cards. The first interface (CN14 with SIM card slot) is the default defined ONLY for mSATA storage. The second interface (CN31) is the half size PCI Express mini card. The third and fourth (CN14/CN15) interface is mainly targeted at supporting iDoor technology/modules for diverse applications such as isolated COM port, Profibus, WLAN GPRS, 3G, mRAM and iDoor Module. Users can install the card easily using the optional kit, please refer to Chapter 3.5 for details.

**Note!** An additional SIM card slot is disabled. Please note you still require 3G Mini-PCIe BUILT-IN SIM card slot module installed to be able to use 3G functions.

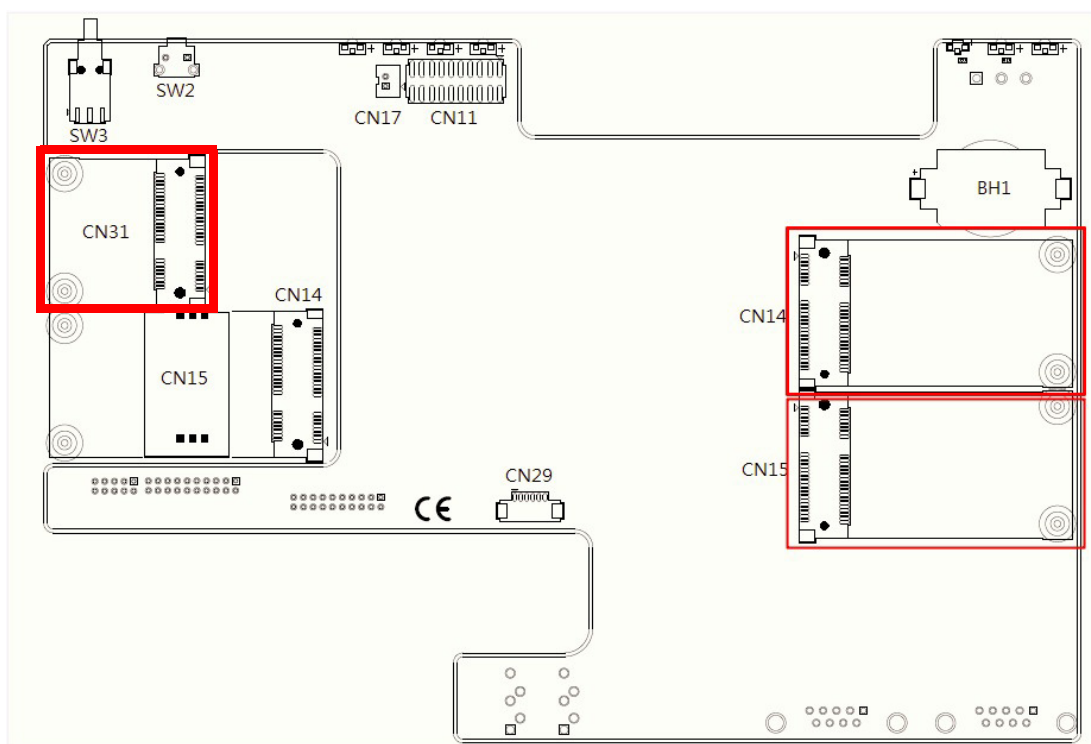



# Chapter 3

## Initial Setup

This chapter introduces how to initialize the UNO-2483G/UNO-2473G.

Sections include:

- Inserting a CFast Card
- Chassis Grounding
- Connecting Power
- Connecting a Hard Disk
- BIOS Setup and System Assignments

## 3.1 Inserting a mSATA

1. Remove the power cord.
2. Unscrew the six screws in the bottom cover.
3. Plug a mSATA card with your OS and application program into the first mPCIe slot CN14 with SIM card.
4. Screw the two screws on board to fix mSATA.
5. Screw back the bottom cover.

## 3.2 Chassis Grounding

UNO-2483G provides good EMI protection and a stable grounding base. There is an easy-to-connect chassis grounding point to use.

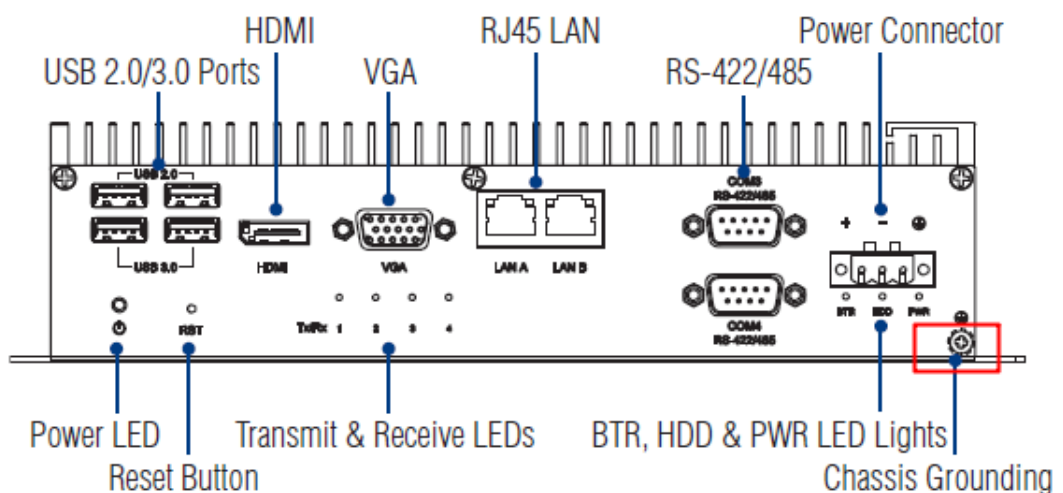

Figure 3.1 Chassis Grounding Connection

Please also note that system ground and chassis ground are separated in the UNO-2483G/2473G.

## 3.3 Connecting Power

Connect the UNO-2483G/2473G to a 24 V<sub>DC</sub> power source. The power source can either be from a power adapter or an in-house power source.

## 3.4 Installing a Hard Disk

The procedure for installing a hard disk into the UNO-2483G/2473G is below. Please follow these steps carefully. Please note the system is not compatible with +12V HDD. Please use a HDD with lower power input.

1. Remove the power cord.
2. Unscrew the four screws from the bottom cover.
3. Screw HDD to the bottom cover.
4. Connect the SATA signal with power cable (already connected with M/B) to hard disk. Then connect the other side of the cable to SATA hard disk.

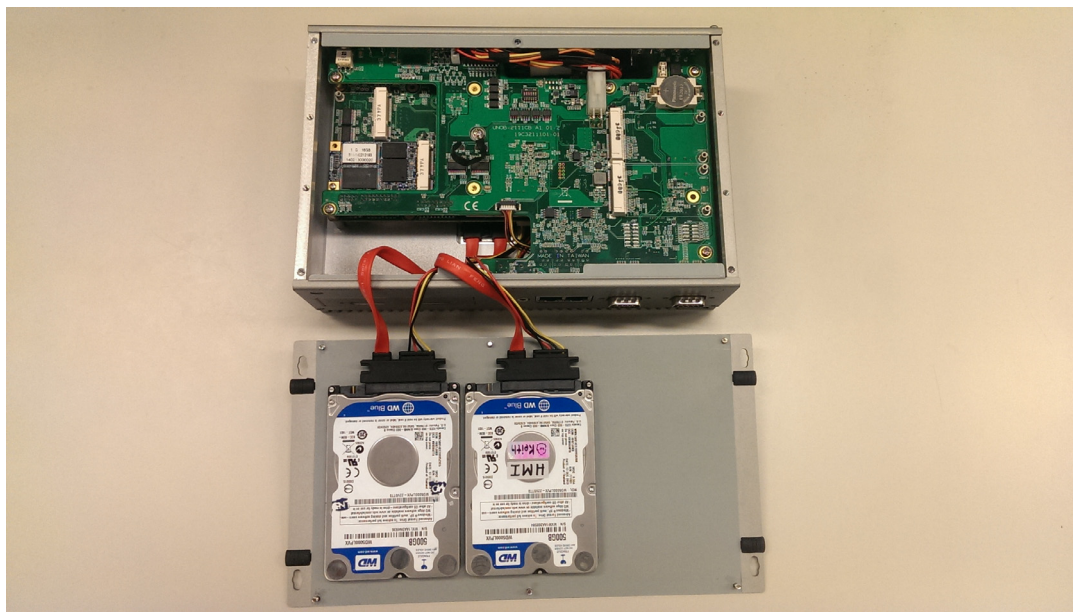

5. Secure the bottom cover with four screws.



## 3.5 Installing a Wireless LAN Card and Antenna

Please contact Advantech to prepare the following optional kit:

### Rear Panel for Antenna

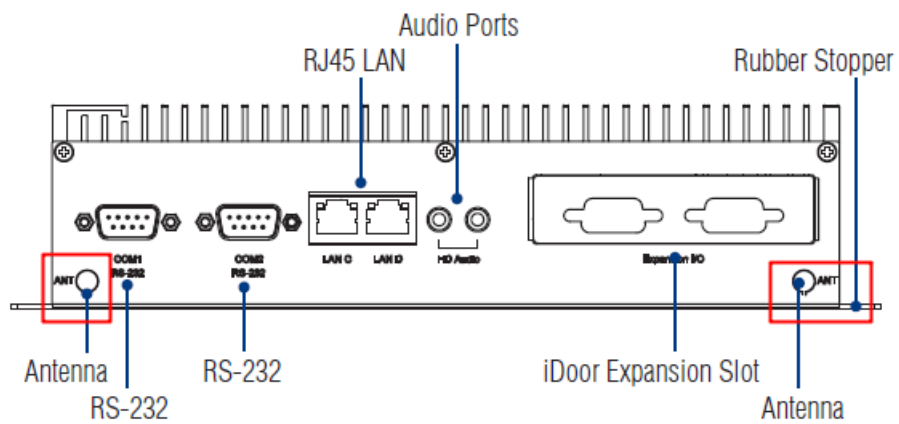

- The internal cable: 1750006043 (15cm)

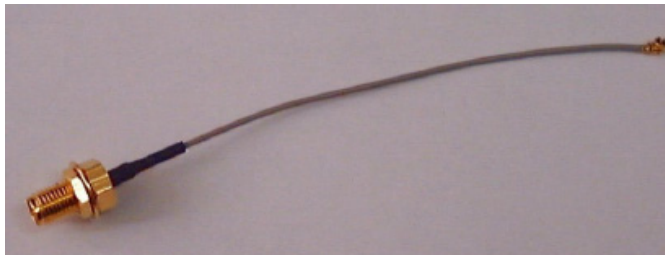

### Wireless Module (PCI Express mini card)

- One of the suggested module is EWM-W151H01E which is a verified Wireless IEEE 802.11b/g/n module

## Antenna

- Please select the necessary specification according to your application.
- One of the suggested antenna is 1750002842.



Then follow the below steps for the installation:

1. Unscrew the bottom panel and open it.
2. Remove the hole(s) on the rear panel for antenna installation.
3. Install the internal cable 1750006043 (15cm) on the rear panel.
4. Plug the Wireless module with bracket kit (9656EWMG00E) onto the PCI Express mini card socket (CN14 and CN15).

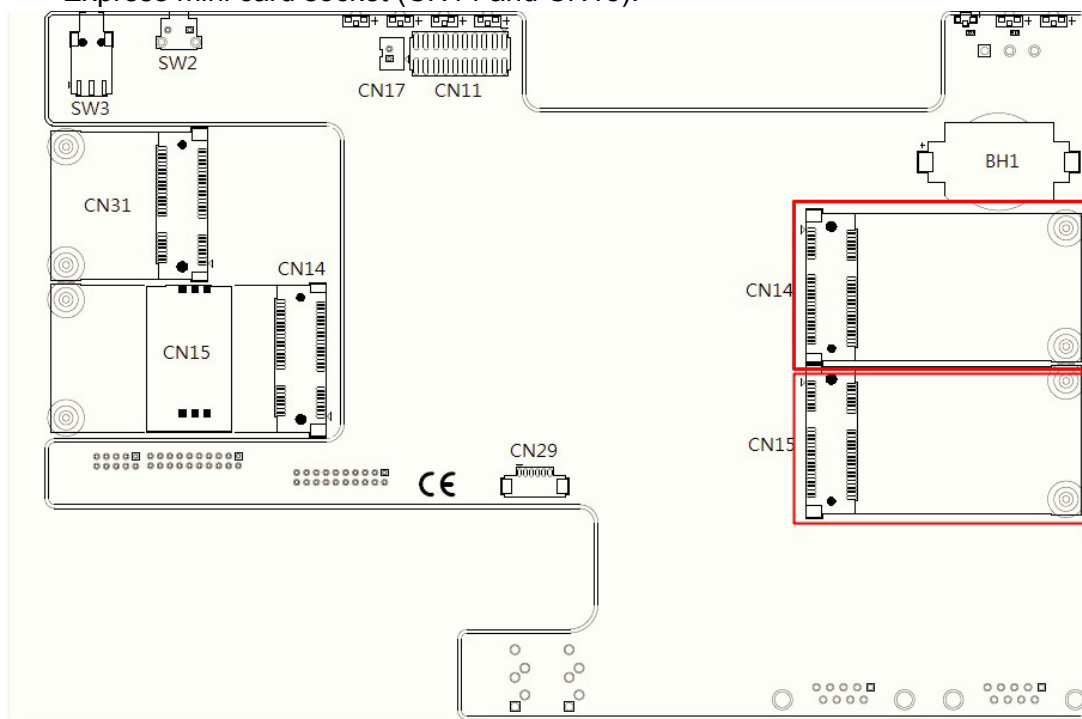

5. Connect the internal cable with the module.
6. Secure the bottom panel.
7. Assemble the antenna on the SMA connector.

## 3.6 BIOS Setup

Press “F2” in the boot-up screen to enter the BIOS setup utility. Please follow the instruction on the screen to do the necessary settings.

Please note that you can try to “Load Optimized Defaults” from the BIOS Setup manual if the UNO-2483G/2473G does not work properly.

## 3.7 AMT Configuration

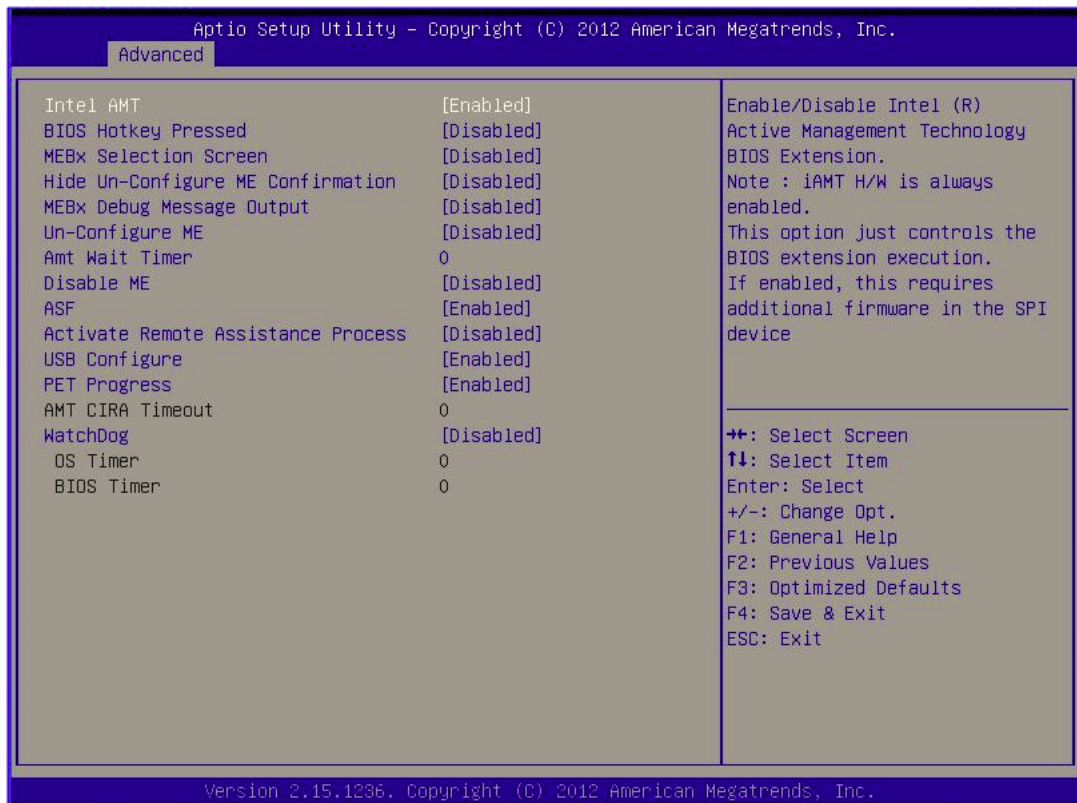

- **Intel AMT**  
This item allows users to enable or disable Intel AMT BIOS extension.
- **BIOS Hotkey Pressed**  
This item allows users to enable or disable BIOS hotkey pressed.
- **MEBx Selection Screen**  
This item allows users to enable or disable MEBx selection screen.
- **Hide Un-configuration ME confirmation**  
This item allows users to hide un-configured ME without password confirmation prompt.
- **MEBx Debug Message Output**  
This item allows users to enable or disable MEBx debug message.
- **Un-Configured ME**  
This item allows users to Un-configure ME without password.
- **Amt Wait Timer**  
Set timer to wait before sending ASF\_GET\_BOOT\_OPTIONS.
- **Disable ME**  
This item allows users to enable or disable ME.
- **ASF**  
This item allows users to enable or disable ASF Configure Function.
- **Activate Remote Assistance Process**  
This item allows users to enable or disable PET event progress to receive PET events or not.
- **USB Configure**  
This item allows users to enable or disable USB Configure Function.



- **PET Progress**  
This item allows to enable or disable PET event progress to receive PET events or not.
- **AMT CIRA Timeout**  
OEM defined time out for MPS connection to be established.
- **Watchdog**  
This item allows users to enable or disable WatchDog Timer.
- **OS Timer**  
Sets OS Watchdog Timer.
- **BIOS Timer**  
Sets BIOS Watchdog timer.

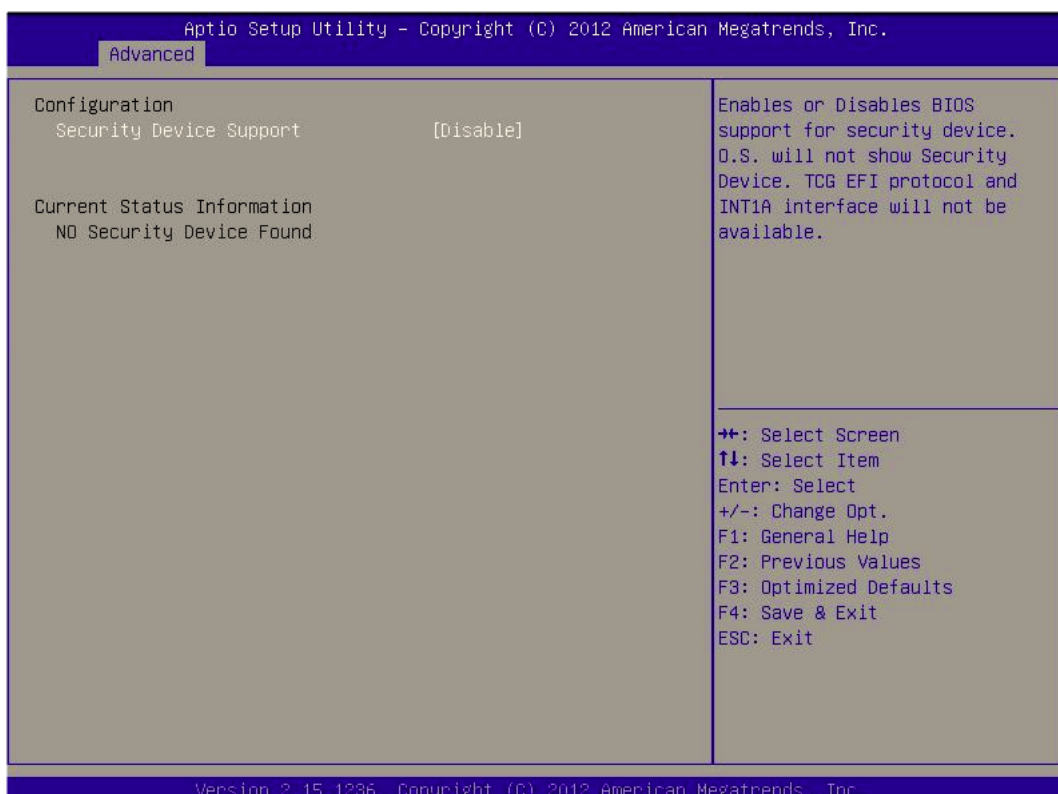

- **TPM Support**  
This item allows users to enable or disable Trusted Platform Module function.

## 3.8 Teaming Configuration

1. Please install the OS and LAN driver first.
2. After entering the OS, please right click the mouse on Network adaptors to configure the Network Connection properties in the device manager.

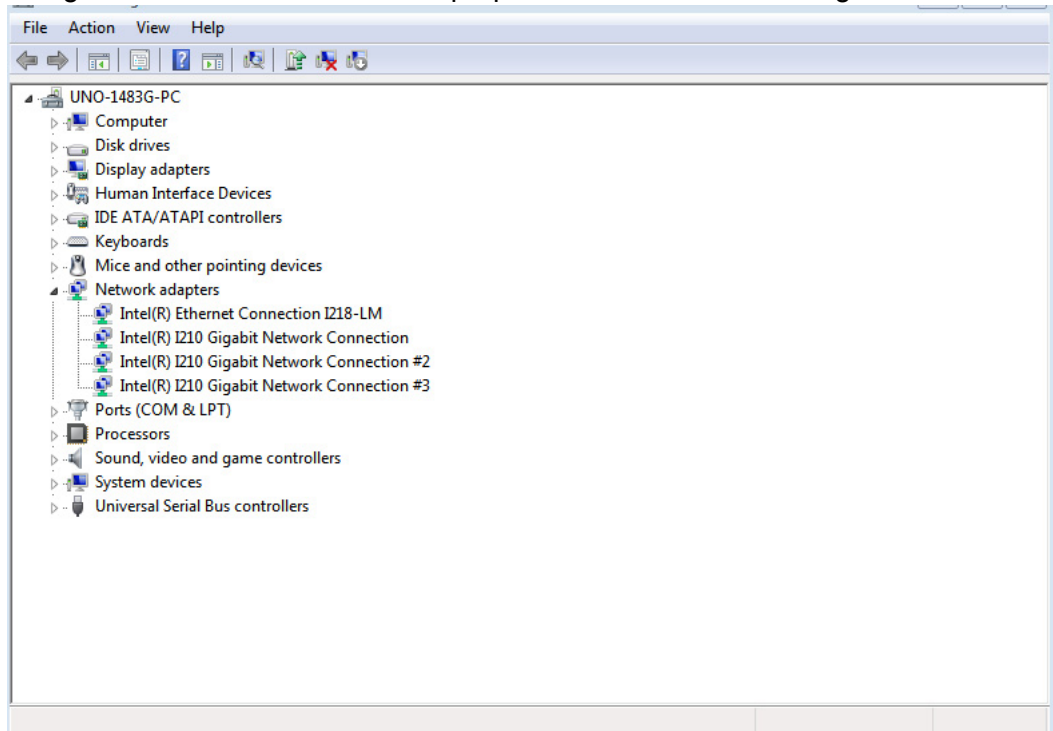

3. Set Teaming with other adapters in Teaming and then press New Team.

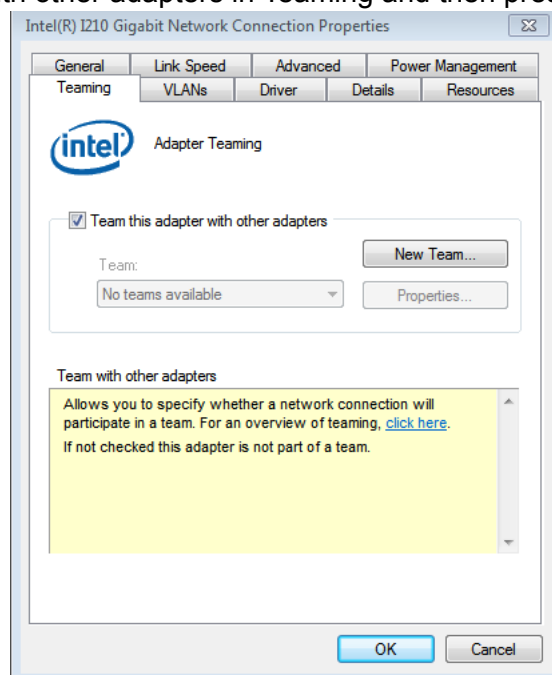

4. Select the adapters to include in this team then press Next.

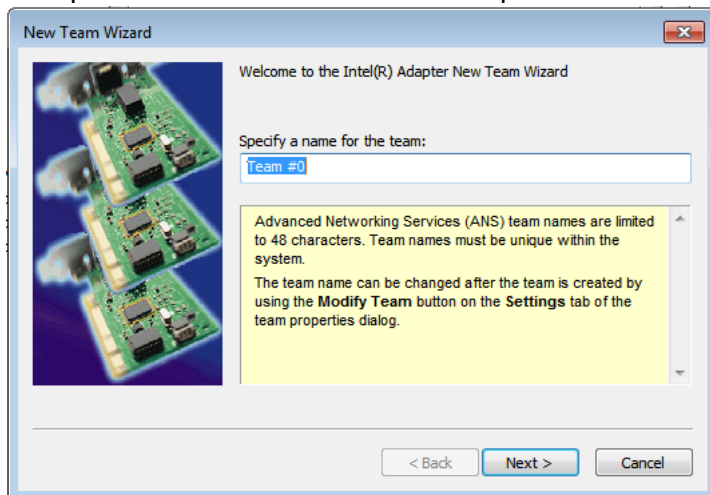

5. Specify the name for the team then press Next.

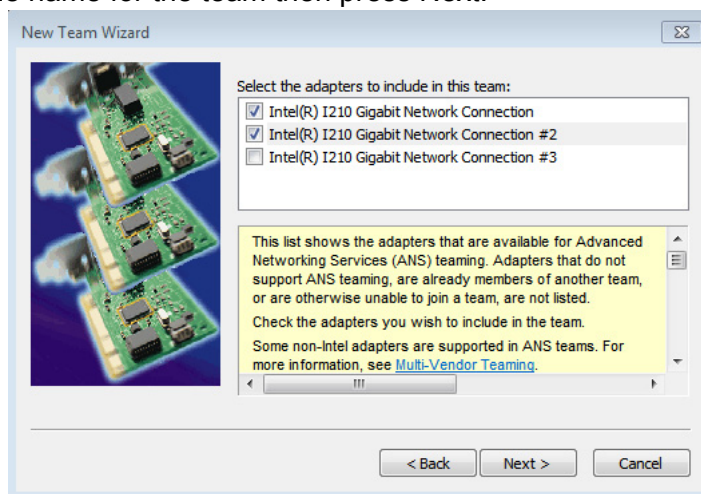

6. Select a team mode. Here Adaptive Load Balancing is chosen.

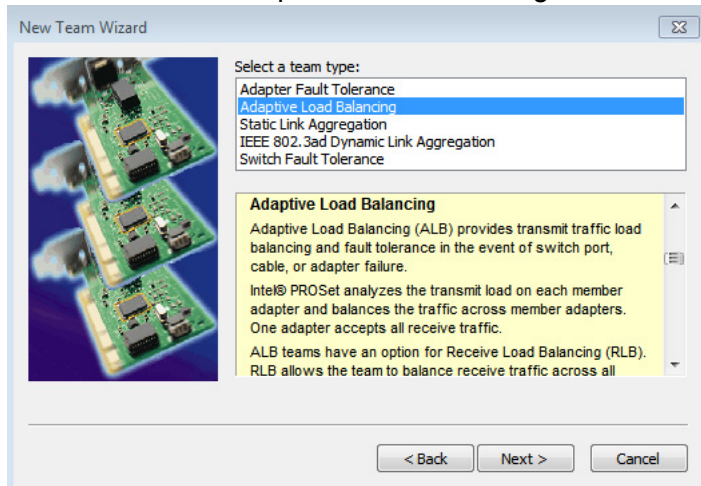

7. Finally, the wizard has the settings needed to create the team, and you'll find out the Network adapters will show as a team in the device manager.

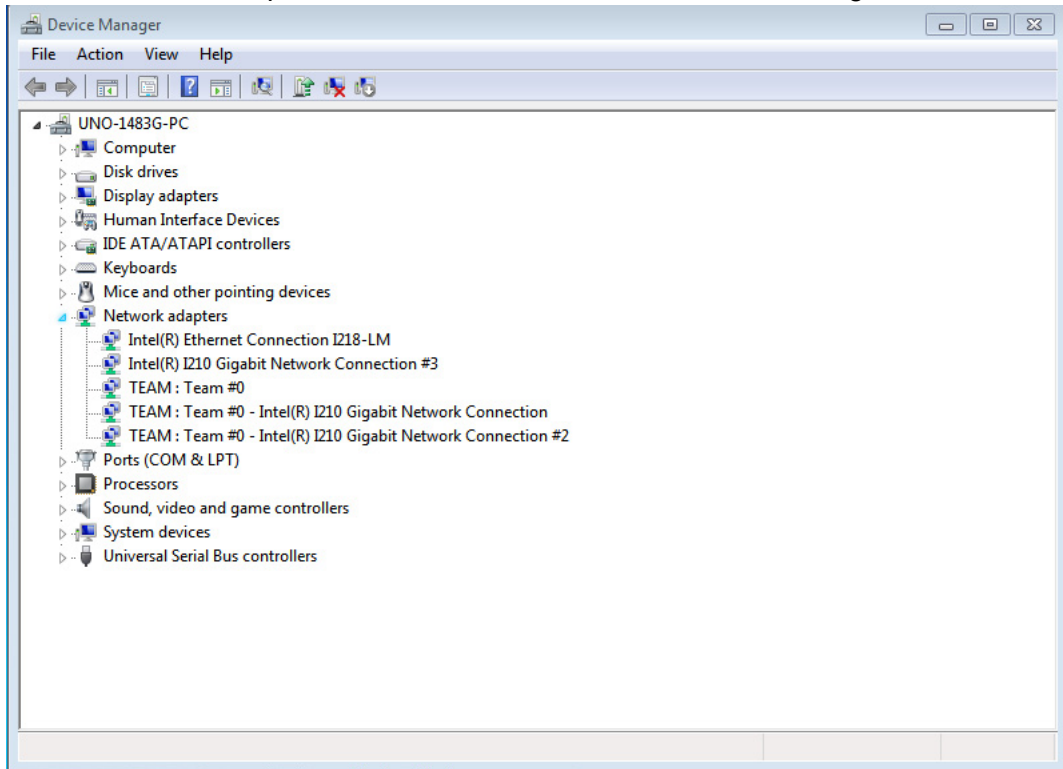

### 3.9 Enabling RAID in BIOS

1. Press the **DEL** key after the Power-On-Self-Test (POST) memory test begins.
2. Select the **Advanced** menu, then the SATA Configuration menu.
3. Set the SATA Mode Select option to RAID.
4. Press the **F10** key to save the BIOS settings and exit the BIOS Setup program.

# Appendix **A**

System Settings and  
Pin Assignments

## A.1 System I/O Address and Interrupt Assignment

**Table A.1: Interrupt Assignments**

<b>Interrupt No.</b>	<b>Interrupt Source</b>
<b>NMI</b>	<b>Parity Error Detected</b>
IRQ0	System timer
IRQ1	Standard 101/102-Key or Microsoft Natural PS/2Keyboard
IRQ2	Interrupt from controller 2 (cascade)
IRQ3	Communications Port (COM2)
IRQ4	Communications Port (COM1)
IRQ5	Communications Port (COM4)
IRQ6	Available
IRQ8	System CMOS/Real-time clock
IRQ9	Microsoft ACPI-Compliant System
IRQ10	Communications Port (COM3)
IRQ12	PS/2 Compatible Mouse
IRQ13	Numeric data processor
IRQ14	Reserved
IRQ15	Reserved

## A.2 Board Connectors and Jumpers

There are several connectors and jumpers on the UNO-2483G/2473G board. The following sections tell you how to configure the UNO-2483G/2473G hardware setting. Figure A.1 shows the locations of UNO-2483G/2473G's connectors and jumpers.

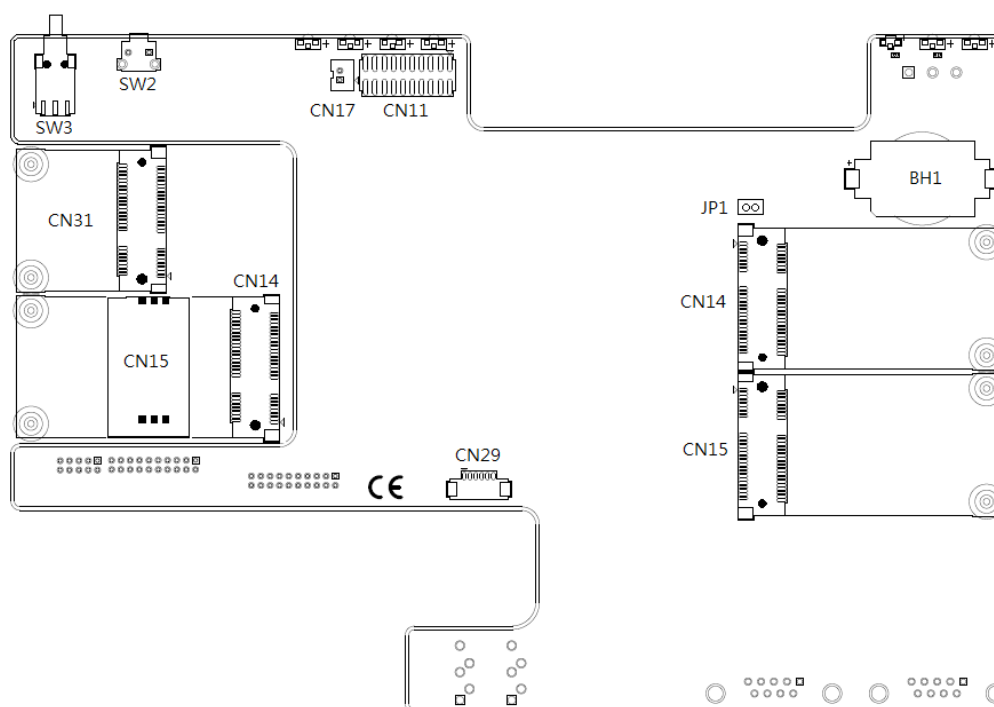
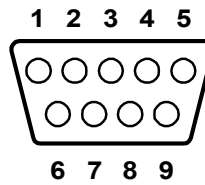

**Figure A.1 Connector & Jumper Locations (front)**

**Table A.2: Connectors and Jumpers**

Label	Function
CN14 CN15	PCI Express mini Card Socket
JP1	Clear CMOS
BH1	Battery for RTC
CN29	ON/OFF/RESET Switch
CN11	COM3, COM4

## A.3 RS-232 Standard Serial Port



**Table A.3: RS-232 Serial Port Pin Assignments**

Pin	Pin Name
1	DCD
2	RxD
3	TxD
4	DTR
5	GND
6	DSR
7	RTS
8	CTS
9	RI

## A.4 RS-422/485 Serial Port

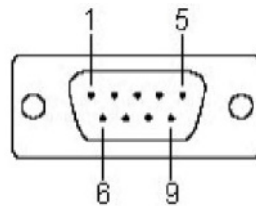
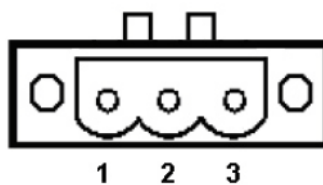

**Table A.4: RS-422/485 Serial Port Pin Assignments**

Pin	RS-422	RS-485
1	TX-	Data-
2	TX+	Data+
3	RX+	NC
4	RX-	NC
5	GND	GND
6	NC	NC
7	NC	NC
8	NC	NC
9	NC	NC



## A.5 Power Connector (PWR)



**Table A.5: Power connector pin assignments**

Pin	
1	V+ (24VDC)
2	V-
3	Field Ground

## A.6 USB Connector

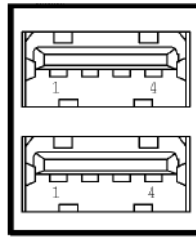

**Table A.6: USB 2.0 Connector Pin Assignments**

Pin	Signal Name	Cable Color
1	VCC	Red
2	DATA-	White
3	DATA+	Green
4	GND	Black

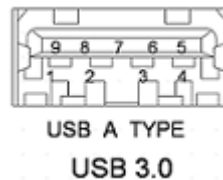

**Table A.7: USB 3.0 Connector Pin Assignments**

Pin	Signal Name	Description
1	VBUS	Power
2	D-	USB2.0 differential pair
3	D+	
4	GND	Ground for power return
5	StdA_SSRX-	SuperSpeed receiver differential pair
6	StdA_SSRX+	
7	GND_DRIAN	Ground for signal return
8	StdA_SSTX-	SuperSpeed transmitter differential pair
9	StdA_SSTX+	

## A.7 HDMI Display Connector

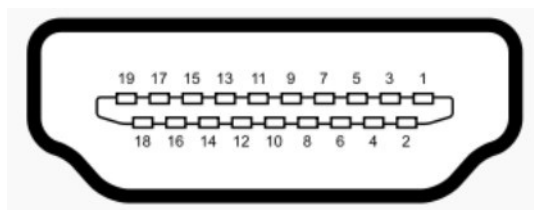

**Table A.8: HDMI Display Connector**

Pin	Signal	Pin	Signal
1	TMDS Data2+	2	TMDS Data2 Shield
3	TMDS Data2-	4	TMDS Data1+
5	TMDS Data1 Shield	6	TMDS Data1-
7	TMDS Data0+	8	TMDS Data0 Shield
9	TMDS Data0-	10	TMDS Clock+
11	TMDS Clock Shield	12	TMDS Clock-
13	CEC	14	Reserved
15	SCL	16	SDA
17	DDC/CEC/HEC Ground	18	+5 V Power (max 50 mA)
19	Hot Plug Detect		

## A.8 Clear CMOS (JP1)

This jumper is used to erase CMOS data and reset system BIOS information. Follow the procedures below to clear the CMOS.

1. Turn off the system.
2. Close jumper JP1 (1-2) to clear CMOS .
3. Remove jumper JP1 (1-2)
4. Turn on the system. The CMOS is now cleared.
5. Turn on the system. The BIOS is reset to its default setting.

**Table A.9: JP1 Clear CMOS**

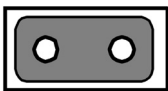
Configuration	Function
	Clear CMOS

## [www.advantech.com](http://www.advantech.com)

Please verify specifications before quoting. This guide is intended for reference purposes only.

All product specifications are subject to change without notice.

No part of this publication may be reproduced in any form or by any means, electronic, photocopying, recording or otherwise, without prior written permission of the publisher.

All brand and product names are trademarks or registered trademarks of their respective companies.

© Advantech Co., Ltd. 2014