

PCE-5033

LGA1700 12th Generation Intel® Core™ i9/i7/i5/i3/Pentium® System Host Board with DDR5, SATA 3.0, USB 3.2, Dual 2.5GbE, and Triple Displays

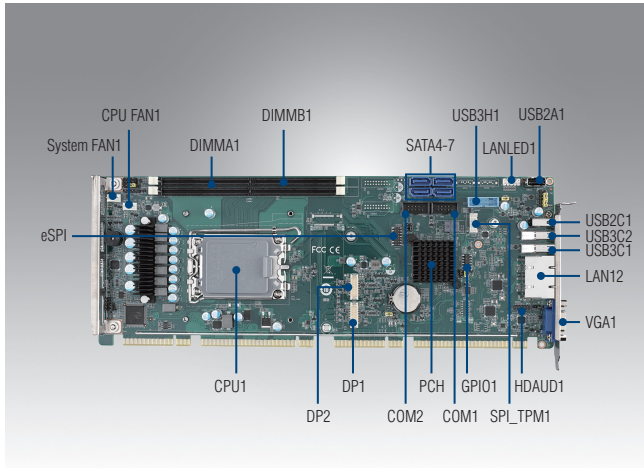

Features

- Intel® Core™ i9/i7/i5/i3/Pentium LGA1700 processor with H610E chipset
- Up to 64 GB of dual-channel (Non-ECC) DDR5 4800 MHz
- PCIe 3.0, USB 3.2, SATA 3.0, and Dual 2.5GbE LAN
- Supports VGA and 2 x DVI-D/DP/HDMI display (with optional cable)
- Supports Advantech's TPM and COM modules, SUSI 4.0, and embedded software APIs

Note: Legacy platform is not supported.

Quiet

Specifications

CE FCC

Processor System	CPU	i9-12900(E)	i9-12900TE	i7-12700(E)	i7-12700TE	i5-12500(E)	i5-12500TE	i3-12100(E)	i3-12100TE	Pentium G7400E	Pentium G7400TE	Celeron G6900E	Celeron G6900TE	
	P-core Base Frequency	2.3GHz	1.1GHz	2.1GHz	1.4GHz	2.9GHz	1.9GHz	3.2GHz	2.1GHz	3.6GHz	3.0GHz	3.0GHz	2.4GHz	
	L3 Cache	30MB	30MB	25MB	25MB	18MB	18MB	12MB	12MB	6MB	6MB	4MB	4MB	
	Cores	16	16	12	12	6	6	4	4	2	2	2	2	
	Processor Base Power	65W	35W	65W	35W	65W	35W	65W	35W	46W	35W	46W	35W	
	Socket	LGA 1700												
	Chipset	H610												
BIOS	AMI 256MB SPI Flash													
Bus	PCI-Express	1 x PCIe x16 and 1 x PCIe x4 to backplane												
	PCI	4 x PCI master to backplane, 32-bit, 33 MHz												
Memory	Technology	Dual-channel (Non-ECC) U-DIMM DDR5 4800 MHz												
	Max. Capacity	Up to 64GB (based on CPU)												
	Socket	2 x DDR5 288-pin DIMM												
Graphics	Controller	Chipset integrated with Intel® UHD Graphics												
	VRAM	Shared system memory is subject to OS												
	VGA	Supports resolutions of up to 2048 x 1152 pixel @ 60 MHz												
	DVI-D	Supports resolutions of up to 1920x 1200 @ 60 MHz												
	Display Port	Supports resolutions of up to 4096 x 2160 @ 60 MHz												
	HDMI	Supports resolutions of up to 1920 x 1080 @ 60MHz												
Ethernet	Triple Display	1st: VGA, 2nd DP/DVI-D/HDMI, 3rd DP/DVI-D/HDMI (2nd and 3rd display via optional cable)												
	Interface	10/100/1000/2500 Mbps												
	Controller	LAN 1: Intel® I226V LAN 2: Intel® I226V												
Rear I/O	Connector with LED	2 x RJ45												
	USB 3.2 Gen1	2												
	USB2.0	1												
	Ethernet	2												
Internal Connector	VGA	1												
	USB	5 x USB 2.0 (1 USB Type A + 4 to backplane), 4 x USB 3.2												
	SATA	4												
	M.2 (2280 Type M)	N/A												
	DP/DVI-D/HDMI	2 (Pin header)												
	COM	2 x RS232												
Watchdog Timer	GPIO	8bit												
	Output Interval	System reset Programmable 1-255 sec												
Miscellaneous	Audio	Intel® High Definition audio interface (requires audio extension module PCA-AUDIO-HDB1E)												
Power Requirement	Test Environment	Intel i9-12900E, Memory *2 DDR5 16GB												
	Voltage	+3.3V, +5V, +12V												
	Current	2.52A, 4.13A, 6.86A												
Environment	Operating Temperature	0 ~ 60 °C (dependent on CPU and cooler solution)									Non-Operating -40 ~ 85 °C			
	Humidity	40 °C @ 85% relative humidity (non-condensing)									60 °C @ 95% relative humidity (non-condensing)			
Physical	Dimensions (L x H)	338 x 122 mm (13.3" x 4.8")												

Note: Power must be turned off before installing any expansion modules

Block Diagram

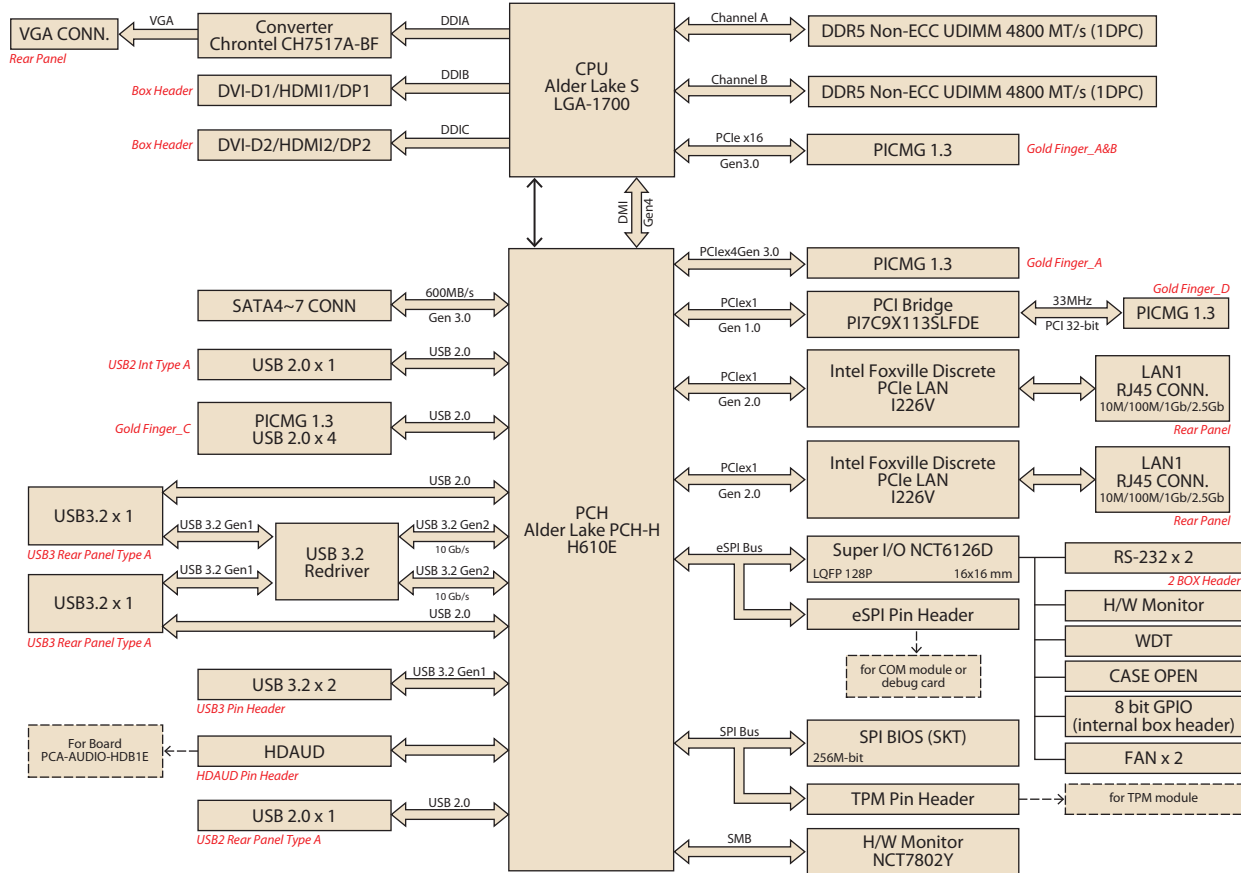

Ordering Information

Part Number	PCH	Memory	Backplane	LAN	VGA	DP/DVI-D/HDMI	COM	SATA III	M.2	USB 2.0	USB 3.2 (Gen1)	USB 3.2 (Gen2)	S/W Raid	AMT
PCE-5033G2-00A1	H610E	Non-ECC	PCE-5BXX	2	Yes	2*	2	4	N/A	2	4	N/A	N/A	N/A

Note: DP/DVI/HDMI cable is optional

Packing List

Part Number	Description	Quantity
1700003194	Serial ATA HDD data cable	x2
1701090401	COM cable w/ BKT 40cm	x1
2190000902	Warranty card	x1
2041513300	Startup manual	x1

Optional Accessories

Part Number	Description
1970005349T000	CPU cooler for 2U, 4U, and dwall-mount chassis (for CPUBase Power=35~125W)
PCA-AUDIO-HDB1E	Audio module
PCA-COM232-ESPA1	4-port RS-232 eSPI module
PCA-COM485-ESPA1	4-port RS-422/485 eSPI module
1700002204	2-port USB2.0 cable w/BKT (27 cm)
1700020277-01	2-port USB 3.0 cable w/ BKT (30 cm)
1700031719-01	4-port USB 3.0 cable w/ BRK (30 cm)
1700021831-01	DP to DVI-D cable w/ BKT
1701090401	1-port COM cable kit
1701092300	2-port COM cable kit
PCE-DP10-00A1E	DP to DP cable w/ BKT
TBD	DP to HDMI cable w/ BKT
PCA-TPMSPI-00A1	dTPM 2.0 SPI module to enable TPM and vPro technologies
20706WX1HS0020	PCE-5033 win 10 embedded OS (high-end)
20706WX1VS0020	PCE-5033 win 10 embedded OS (value)
20706WX1ES0020	PCE-5033 win 10 embedded OS (entry)

I/O View



PCE-5033G2-00A1